

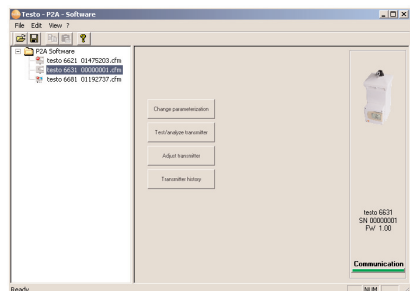

testo 6631 Bio research transmitter
P2A-Software for testo 6631

Instruction manual

en



Contents

Contents	3
Safety and the environment.....	4
Part 1: testo 6631	
Specifications	5
Voltage supply	6
Product description.....	9
Commissioning	10
Connecting instrument	10
Electrical connection	11
Parameterizing/adjusting/analyzing the instrument	12
Maintaining the product	13
Tips and assistance	14
Part 2: testo P2A Software	
Specifications	15
First steps	16
Installing the software / driver	16
Starting the software	16
Product description.....	17
Using the product	18
Tips and assistance	23

Safety and the environment

About this document

- › Please read this documentation through carefully and familiarize yourself with the product before putting it to use. Keep this documentation to hand so that you can refer to it when necessary. Hand this documentation on to any subsequent users of the product.
- › Pay particular attention to information emphasized by the following symbols:



- With the signal word **Caution!**:
Warns against hazards which could result in minor physical injury or damage to equipment if the precautionary measures indicated are not taken.



- Important.

Avoiding personal injury / damage to equipment

- › Never store the product together with solvents and do not use any desiccants.
- › Only operate the product properly, for its intended purpose and within the parameters specified in the technical data. Do not use force.
- › Only carry out the maintenance and repair work that is described in the documentation. Follow the prescribed steps when doing so. Use only OEM spare parts from Testo.

Protecting the environment

- › Send the product back to Testo at the end of its useful life. We will ensure that it is disposed of in an environmentally friendly manner.

PART 1: TESTO 6631

Specifications

Functions and use

The testo 6631 is a bio research humidity transmitter for relative humidity and temperature. The sensors are located in the housing. The transmitter is available with an integrated display for the reading as an option (cannot be retrofitted by the customer).

Process security and system availability, as two of the most important parameters in experimental facilities, are supported by a number of properties of the testo 6631 bio research transmitter:

- Long-term stability and reliability thanks to the precise Testo humidity sensor
- Integrated ventilator allows targeted flow impact onto the sensor, making the recording of mean climate conditions within greenhouse cells.
- Time savings in commissioning and maintenance due to
 - Parameterization, adjustment and analysis software (P2A)
 - Easy and fast ventilator replacement thanks to ventilator drawer assembly and plug-in cable
 - Sensor replacement as well as adjustment possibility using saline pots through easily accessible service opening

The transmitters must only be assembled, wired and connected by qualified personnel.

The product must **not** be used in areas at risk of explosion!

Ordering overview

0555 6631 Bxx / Cxx / Fxx / Gxx / Mxx / Kxx	
B01	4 - 20 mA (2-wire), with separate ventilator supply
B06	4 - 20 mA (4-wire), with integrated ventilator supply
C00	Without display
C01	With display
F01	Relative humidity (% RH)
G02	Temperature (°C)
G03	Temperature (°F)
M01	Sintered stainless steel filter
M03	Sintered PTFE filter
M05	Open plastic cap
K01	Language versions of the instruction manual German-English
K02	Language versions of the instruction manual French-English
K03	Language versions of the instruction manual Spanish-English
K04	Language versions of the instruction manual Italian-English
K05	Language versions of the instruction manual Dutch-English
K06	Language versions of the instruction manual Japanese-English
K07	Language versions of the instruction manual Chinese-English

Sample orders testo 6631

.. 4 ... 20 mA (2-wire), with display, %rF/°C, Bedienungsanleitung Deutsch-Englisch:
0555 6631 / B01 / C01 / F01 / G02 / M05 / K01

Technical data

Sensor

- Humidity: Testo humidity sensor, temperature: NTC
- Temperature NTC plug-in

Measuring ranges

- Humidity: 0 - 100 % RH (not for high humidity process)
- Temperature: -10 - +60 °C/14 - 140 °F

Accuracy

- Humidity: ± 2.5 % RH (0 - 90 % RH), ± 4 % RH (> 90 - 100 % RH)
- Temperature active : ± 0.5 °C/0.9 °F

Reaction time (with protective cap and ventilator running)

- Humidity: max. 5 sec (t63% ~~time~~)
- Temperature: max. 20 sec (t63% ~~time~~)

Analog outputs

- Humidity: 4...20mA (2 or 4-wire)
- Temperature: 4...20mA (2 or 4-wire)
- Meas. rate: 1/s

Voltage supply

- 24 V AC/DC \pm 10% AC

Ambient conditions

- Operating temperature: -10...+60°C / 14...140°F
- Storage temperature: -20...70°C / -4...158°F

Housing

- Material: ABS, UV-proof
- Colour: white
- Dimensions 105 x 139 x 225 mm
- Weight: <800 g,
- Protection class : IP66
- Weight: 1000 g
- Protection class transmitter: IP 65
- Protection class housing: IP 33

Display (optional)

- 2-line LCD

Directives, standards and tests

- EC Directive: 2004/108/EEC
- EMC DIN EN 61000-6-2 (Immunity)
- DIN EN 61000-6-3 (Emission)

Guarantee

- Duration: 2 years

Ventilator

- Max. volume flow: 46.80 m³/h / 13 l/s
- Life expectancy: 37,500 h (40°C)
- Ventilator housing/vane: metal/metal
- Bearing system: slide bearing
- 24 VAC 12 W

Dimensions

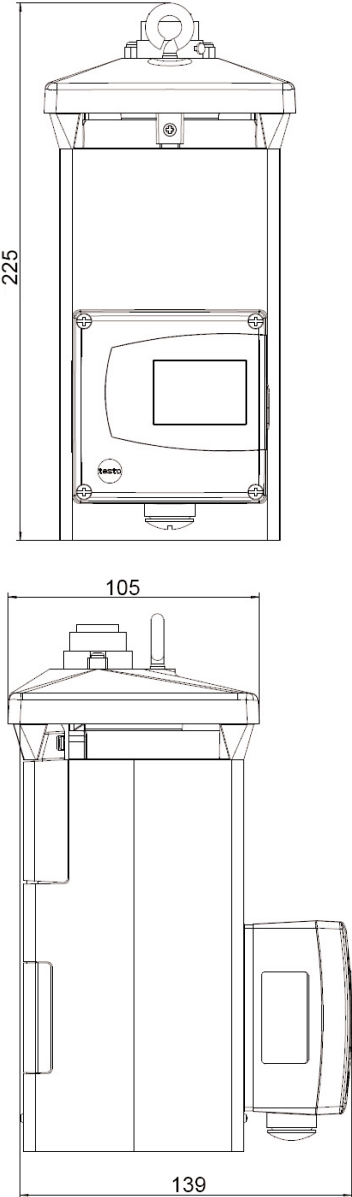

Product description

At a glance

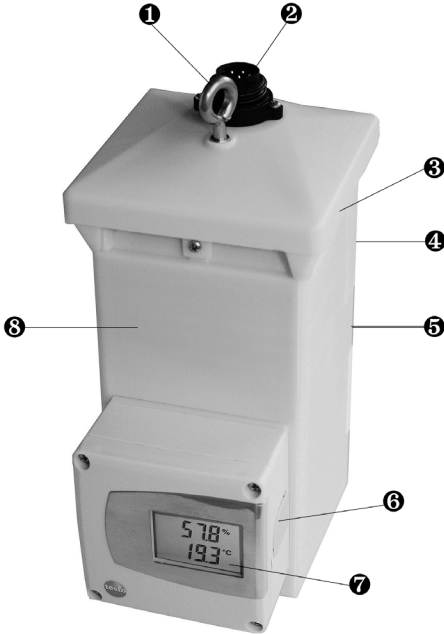

- ① Suspension ring
- ② Voltage supply / signal output
- ③ Ventilator
- ④ Ventilator drawer assembly (rear).
- ⑤ Service opening for humidity sensor (rear)
- ⑥ Mini-DIN-connection for P2A software and 1-point adjustment.
- ⑦ Two line display
- ⑧ Ventilation shaft

Commissioning

Connecting instrument

> Replacing ventilator:



1. Connect plug-in cable.
2. Place ventilator drawer assembly into housing.
3. Tighten screw on ventilator drawer assembly.

> Install instrument in a suitable position:

- 1 Connect the supply line to the socket plug on the instrument.

Electrical connection

2-wire technology

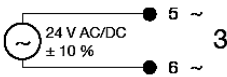
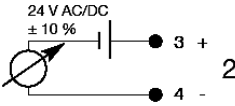
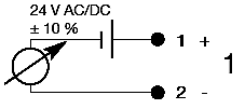

7 4

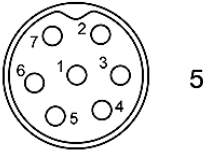

- Plug manufacturer: Euchner
 - Cable socket (not included in delivery): Type BS 7K
 - Pin socket (fitted in instrument ex-works): Type SD 7K
- 1 %RH (4...20mA)
 - 2 °C/°F (4...20mA)
 - 3 AC ventilator
 - 4 Not in use
 - 5 Top view of plug socket

DC: Supply transmitter
AC: Supply ventilator

4-wire technology

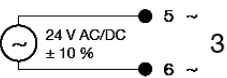
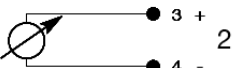
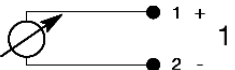

4

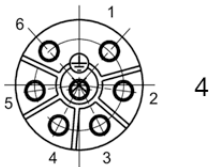

- Plug manufacturer: Firma Tuchel-Amphenol
 - Cable socket (not included in delivery): Type 01630D00610010
 - Pin socket (fitted in instrument ex-works): Type Eco mate instrument plug
- 1 %RH (4...20mA)
 - 2 °C/°F (4...20mA)
 - 3 AC ventilator and transmitter
 - 4 Top view of plug socket

AC: Supply transmitter and ventilator

Parameterizing/adjusting/analyzing the instrument

i The analog outputs can be scaled in the following ranges, beyond the measurement range of the measurement transmitter: -50...100°C / -58...212°F, -50...150%RH.

i Scaling beyond the measurement range allows the adaptation of the scaling limits to prescribed values from a PLC. The measurement range itself cannot be extended this way.

The instrument is parameterized, adjusted and analyzed using the P2A Software, see “Part 2: testo P2A Software”.

Alternatively, the 1-point adjustment can be carried out using the adapter (accessory, 0554 6022) and a testo 400/650 with reference humidity probe.

1-point adjustment with adapter



- 1 Connect testo 400/650, with reference humidity probe (0636 9741) connected, to the interface of the testo 6631 via the adapter (connected to probe socket 1 of the testo 400/650).
- 2 Expose the testo 6631 and the reference humidity probe to the same reference conditions (e.g. in the humidity generator) and allow climatic conditions to equalize.
- 3 Switch on the testo 400/650. The values of the testo 6631 and reference humidity probe are displayed on the left and right-hand sides of the two-part display of the testo 400/650 respectively.
- 4 Adjust the humidity and temperature values on the reference humidity probe using the **Probe > Probe Adjustment** menu item on the testo 400/650.
- 5 Disconnect the adapter from the interface of the testo 6631.

Maintaining the product



Caution!

Never put your hands inside housing openings when the ventilator is running. This could lead to injury. Disconnect the instrument from the mains supply before cleaning or exchanging the ventilator, and wait until the ventilator has come to a standstill.

> Cleaning the housing:

- > Clean the housing with a damp cloth (soap suds) if it is dirty. Do not use aggressive cleaning agents or solvents!

> Cleaning the sensor

i During cleaning, avoid touching the sensor at all costs.



1. Remove service opening.
2. Unscrew sensor protection cap.
3. Carefully rinse the mirrored surface with isopropyl alcohol and/or distilled water.
4. Allow the sensor to dry completely.
5. Unscrew sensor protection cover.
6. Close service opening.

> Exchanging sensor



1. Loosen screw on the ventilator drawer assembly.
2. Remove drawer assembly with the ventilator from the housing.
3. Disconnect plug-in cable.
4. Remove ventilator from drawer assembly using Allen key.
5. Fix new ventilator into drawer assembly using Allen key.
6. Connect plug-in cable.

7. Place drawer assembly with ventilator into housing.
8. Tighten screw on ventilator drawer assembly.

Tips and assistance

Questions and answers

If you had any question, please contact your dealer or Testo Customer Service. For contact data, see back of this document or web page www.testo.com/service-contact.

Accessories and spare parts

Designation	Article no.
Parameterizing, adjusting and analyzing software (P2A Software incl. adapter cable for USB to mini-DIN)	0554 6020
Adapter (for 1-point adjustment with testo 400/650)	0554 6022
Process display testo 54-2 AC, two relay outputs (to 250 VAC/300 VAC, 3 A), mains power supply 90...260 VAC	5400 7553
Process display testo 54-7 AC, two relay outputs (to 250 VAC/300 VAC, 3 A), mains power supply 90...260 VAC, with RS485-output for Online Monitoring and with toatlizer display	5400 7555
Humidity adjustment set(11.3% and 75.3%RH)	0554 0660
ISO calibration certificate humidity at 11.3% and 75.3%RH	0520 0076

For a complete list of all accessories and spare parts, please refer to the product catalogues and brochures or look up our website at: www.testo.com

PART 2: TESTO P2A SOFTWARE

Specifications

Functions and use

The testo P2A Software (0554 6020) is parameterizing, adjusting and analyzing software for Testo transmitters. It is not supplied with the testo 6631.

System requirements

Operating system

- Windows 2000 SP4, Windows XP or Windows Vista

Computer

- Pentium processor of at least 400 MHz or equivalent
- 128 MB RAM
- Graphics resolution of at least 1,024 x 768
- Unused hard drive capacity of at least 15 MB
- CD-ROM drive
- USB interface

First steps

Installing the software / driver

The CD supplied with the testo 6631 contains an update of the P2A Software including all the latest instrument drivers. Install this update once you have installed the P2A Software (0554 6020).

i Administrator rights are required for the installation of the testo P2A Software.

> Installing the P2A Software:

- 1 Insert the "P2A Software" CD (0554 6020).
If the installation program does not start automatically:
 - › Start **Setup.exe** file from the CD-directory (access via **My Computer** or **Windows Explorer**).
- 2 Follow the instructions of the installation program.

> Installing the USB drivers:

The USB driver CD is supplied with the P2A Software.

i Before installing the USB drivers, please read the separate documentation enclosed with the USB driver CD.

The installation of the USB driver is the prerequisite for the faultless use of the P2A software.

> P2A Software update:

- 1 Insert the product CD (supplied with the testo 6631).
If the installation program does not start automatically:
 - › Start **Setup.exe** file from the CD-directory (access via **My Computer** or **Windows Explorer**).
- 2 Follow the instructions of the installation program.

Starting the software

> Starting the program:

- › Select:  **Start** > Programs > Testo > P2A Software.

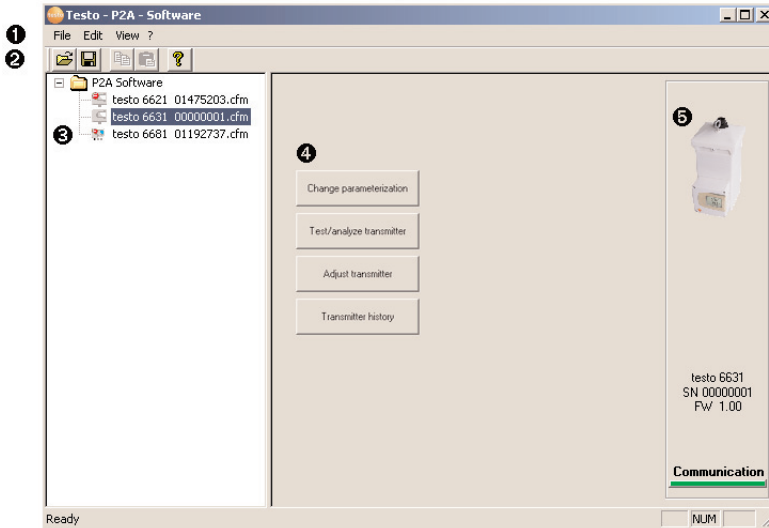

Product description

User interface



- 1 Menu bar.
- 2 Toolbar.
- 3 File list: List of all instrument/parameter files.

File symbols

-  : Instrument file, connection to the unit has not been established.
-  : Instrument file, connection to instrument is established. „[Type] [Serial number].cfm“, File names cannot be altered. Instrument files contain all data on a certain instrument. These are the parameter data and parameterization and adjustment history of the instrument
-  : Parameter file. „[Type] [Serial number] [Date] [Time].cfp“, File names can be altered. ·Parameter files contain only parameter data. These can be copied into another instrument or parameter file of the same instrument type, so that several instruments have the same parameter settings. The name is freely selectable, however it is recommended that the instrument context is retained. Parameter files are always marked in red, the parameter values contained in them are only passed on to the instrument after transfer to the instrument file.

File identifications

- Instrument files: “[Type] [serial number].cfm”; file identifications cannot be changed. Instrument files contain all the data relating to a particular instrument. These are the parameter data and represent the parameterization and adjustment history of the instrument.

- Parameter files: “[Type] [serial number] [date] [time].cfp”; file identifications can be changed. Parameter files only contain parameter data. These can be copied to another instrument or parameter file for the same type of instrument so that several instruments have the same parameter settings.

4 List of functions.

5 Instrument information:

Information displayed

- Instrument files: Type, serial number, firmware version and connection status of the instrument.
- Parameter file: Type, serial number and firmware version of instrument with which the parameter file was created.
- Connection status (instrument files only): “green” connection is active, “red” connection is inactive.

Using the product

> Establishing a connection with the device:

Several instruments can be connected to the PC and administered via the P2A software, but only one connection can ever be active at any one time.

Non-wired instruments can also be connected to the P2A Software for parameterization/adjustment. The supply to the instruments is then effected via the USB interface (analog outputs not functional).

- 1 Connect the USB/mini-DIN adapter to the external interface (mini-DIN) of the instrument.
- 2 Connect the USB connector of the adapter to the PC.
 - The instrument file for the instrument connected appears in the instrument file/parameter file list.

> Selecting the instrument/parameter file, activating a connection with the device:

- › Click on the requisite instrument/parameter file.
 - The selected file is highlighted in colour.
 - For instrument files only: if a connection with the instrument has been established, this is automatically activated.

➤ Changing an instrument/parameter file:

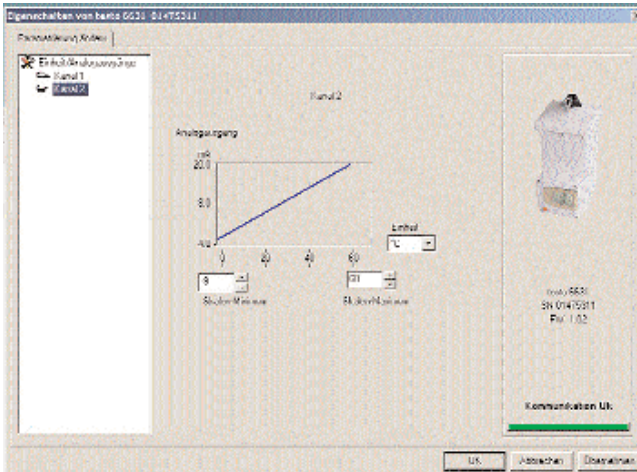

- ✓ The required instrument/parameter file is selected.

- 1 Click on **Change parameterization** button.
- 2 Select channel.
- 3 Enter parameters in the corresponding fields.

Unit / Analog output (Graph)

- Unit: 0...1V / 5V / 10V or 0...20 mA / 4...20 mA. Vertical: Current version of the analog output (not alterable). Horizontal: Min/max. Scale end points of the selected unit. The curve shifts according to the value entered at Scale minimum or maximum.

Scale minimum/maximum

- The end points of the scaling can be selected up to the stored scale minimum and maximum. In order to adapt the analog output to the customer's system, it is possible to scale beyond the end of the measuring range.

Unit

- Selection of the physical unit. When the unit is changed, standard values are set at Scale minimum and maximum. Attention! Changes to the physical unit cause the relay limit values to be set to the allocated default values.

- 4 Click on **Apply** to confirm entries.
- 5 To leave the parameterization screen, click on **OK**.

➤ Saving the parameters in a parameter file:

Parameters can be stored in new parameter files.

- ✓ The required instrument/parameter file is selected.

 - 1 In the menu bar, click on **File > Save as**.

- 2 Select the storage location and enter the file name.
- 3 Click on **Save** to confirm entries.

The new parameter file is stored in the file list

Only the parameters from an instrument file are stored, the history data are not transferred.

i As standard, the original name (instrument type, serial number) with the current date / time is suggested, e. g.. "testo 6631 01234578 061120 1403.cfp". In a standard installation, the files are stored in the path "C:\Documents and Settings\All Users\Common Documents\P2A Software". However, the path can differ depending on the operating system version.

> **Opening a parameter file:**

All parameter files stored in the standard directory path are automatically displayed in the file list when the software is started. Parameter files stored in other directories can also be opened.

i Only parameter data stored in the standard file can be loaded into an instrument!

- 1 In the menu bar, click on **File > Open**.
- 2 Select the storage location and click on the requisite parameter file.
- 3 Click on **Open** to confirm entries.

> **Copying the parameter data:**

The parameter data for an instrument/parameter file can be transferred to another instrument/parameter file for the same type of instrument. History data for instrument files are not transferred.

- 1 Select file from which the parameter data are to be copied.
- 2 In the menu bar, click on **Edit > Copy**.
- 3 Select the file which is to be modified.
- 4 In the menu bar, click on **Edit > Paste**.

> **Analyzing/testing the instrument:**

- ✓ The required instrument file is selected.
- 1 Click on **Test/analyze transmitter** button.
 - 2 Perform tasks:

Options

- Carry out factory reset: Reset the parameter unit, scaling limits and adjustment to the factory settings (Values instrument-specific, see specification plate).

- Transmitter tests (voltage supply via terminals required): Current reading displayed and analog output test carried out for each channel; see below for procedure.
- Min./max. values: Change to display of minimum/maximum values.

Procedure: testing analog output (voltage supply via terminals required)

- 1 Choose channel.
- 2 Connect reference multimeter (min. 6.5 digits resolution) to the analog output terminals of the transmitter.
- 3 Set the default value in the P2A Software and click on **Activate**.
- 4 Compare value displayed with reference value of multimeter.

3 To leave the analyzing/test screen, click on **OK**.

➤ **Carrying out/resetting a 1-point adjustment (offset):**

A testo 400/600 with precision humidity probe is recommended as the reference measuring instrument.

- 1 Click on **Adjust transmitter** button.
 - 2 Select the channel under **1-point adjustment**.
 - 3 Expose the reference measuring instrument and the instrument to be adjusted to the same constant conditions and wait for equalization period to lapse.
 - 4 Enter reference value and perform adjustment by clicking on **Carry out 1-point adjustment**.
- To reset an offset value, click on **Set Offset to zero**.
- 5 Click on **OK** to confirm entries.

➤ **Carrying out a 2-point adjustment:**

i Before the 2-point adjustment, it must be ensured that the ventilator of the testo 6631 is operating, and that the air input opening is not blocked.

- 1 Click on **Adjust transmitter** button.
- 2 Select the adjustment point under **2-point adjustment**.
- 3 To set the humidity generator: Temperature of 25 °C and humidity of 11.3 % RH or 75.3 % RH (depending on adjustment point chosen).
- 4 After a sufficient equalization period (at least 1.5 h): Enter reference value and perform adjustment by clicking on **Lower adjustment point** or **Upper adjustment point** (depending on adjustment point chosen).
- 5 Repeat steps **3** to **4** for the second adjustment point accordingly.
- 6 Click on **OK** to confirm entries.

i For the testo 6631, a 2-point adjustment can also be performed using the testo control and adjustment set (0554 0660). Please also refer to the instruction manual for the control and adjustment set. The reference values are entered and the adjustment is carried out in the same way as

for an adjustment with a humidity generator/air conditioning cabinet (see steps 1 to 6).

> **Carrying out an analog adjustment:**

i Voltage supply via terminals required.

- 1 Click on **Adjust transmitter** button.
- 2 Choose channel.
- 3 Connect reference multimeter (min. 6.5 digits resolution) to the analog output terminals of the transmitter.
- 4 Click on **Start Wizard...** button and follow the instructions issued by the P2A Software.
- 5 Click on **OK** to confirm entries.

> **Viewing a transmitter history:**

The current history data are always displayed as stored in the instrument file. A distinction is made between parameterization and adjustment histories.

i Dates and times refer to the PC time when the P2A Software was being used.

History data are only stored in the instrument file (PC), not in the testo 6631.

- 1 Click on **Transmitter history** button.
- 2 To move between the views, click on **Parameterization history** or **Adjustment history**.
- › To print the history data, click on **Print**.

> Deleting parameters from an instrument/parameter file:

The parameter data for the selected instrument/parameter file can be deleted.

✓ The required instrument/parameter file is selected.

- 1 Right-click on the instrument/parameter file.
- 2 Select **Delete**.
- 3 Click on **Yes** to confirm.

> Creating a new folder:

✓ The folder to which the new folder is to be added is selected.

- 1 In the menu bar, click on **File > Add Folder**.
- 2 Give the new folder a name.

Tips and assistance

Questions and answers

Question	Possible causes/solutions
Connection to instrument cannot be established.	<ul style="list-style-type: none"> · Check connecting cable and plug contacts. · USB driver not/incorrectly installed: Re-install.
Adjustment is to be reversed.	<ul style="list-style-type: none"> · Carry out factory reset: Click on Test/analyze transmitter > Click on Carry out factory reset.

If we could not answer your question, please contact your dealer or Testo Customer Service. For contact data, see back of this document or web page www.testo.com/service-contact



(주)누비콤

서울본사

서울특별시 영등포구 경인로 775(문래동 3가, 에이스하이테크시티 3동 201호)

TEL: 070-7872-0701 FAX: 02-2167-3801

E-mail: sales@nubicom.co.kr

고객지원센터

TEL: 070-7872-0701, 080-801-7880 FAX: 02-2167-3802

E-mail: oft@nubicom.co.kr

대전 사무소

대전광역시 유성구 대덕대로 593(도룡동 386-2) 대덕테크비즈센터 203호

TEL: 070-7872-0712 FAX: 042-863-2023

E-mail: inyeom@nubicom.co.kr

www.testo.co.kr

www.nubicom.co.kr

www.itestoshop.co.kr