



6 Key Challenges of the Internet of Things

A Guide to Building IoT Ready Devices

eBook



Tektronix[®]

Introduction

The Internet of Things (IoT) promises to change the world by connecting devices in larger, more interoperable systems controlled by software and analytics. The proliferation of device, software, and analytics will drive significant changes in most industries, from shipping and transportation to construction and manufacturing. They will even change the way we maintain our own health and fitness. >>

The opportunities to reinvent existing objects into connected devices that include sensors and transmitters are abundant. However, these opportunities are accompanied by technical challenges. How do we make tools and machines that have not changed in form or function for decades into electronic devices that are smart, connected, and compliant? Further, how do we ensure that the devices we design in the lab are able to perform in the field?

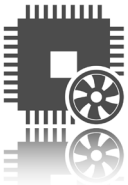
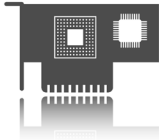
This guide outlines six central challenges associated with building the devices that will populate the Internet of Things, and how those challenges can be addressed.

The Device Food Chain				
What are you building?	Chip	Module	Device	System
				
Key Challenges:	<ul style="list-style-type: none"> > RF Design and Debug > EMI/EMC Pre Compliance 	<ul style="list-style-type: none"> > RF Design and Debug > EMI/EMC Pre Compliance > Speeding Through Wireless Standards 	<ul style="list-style-type: none"> > Selecting a Wireless Module > RF Design and Debug > EMI/EMC Pre Compliance > Maximizing Battery Life in IoT Devices > Speeding Through Wireless Standards 	<ul style="list-style-type: none"> > The Interference of Things



Index

- Challenge: 1** Selecting the Right Wireless Module..... 5
- Challenge: 2** Designing and Debugging Complex Mixed Signal Devices 7
- Challenge: 3** Maximizing Battery Life 10
- Challenge: 4** Passing EMI and EMC Certification 13
- Challenge: 5** Speeding Through Wireless Standards Certification 17
- Challenge: 6** Combatting the Interference of Things..... 20
- Conclusion** 23



Challenge: 1

Selecting the Right Wireless Module

When adding wireless connectivity to your products there are a number of technologies to choose from, including Wi-Fi[®], Bluetooth[®], ZigBee[®]. You may opt to buy a wireless module rather than build your own custom RF design to save time and money. However there are dozens of modules out there, and several factors to consider. >>

With so many modules in production and more coming, choosing a wireless module can feel overwhelming.

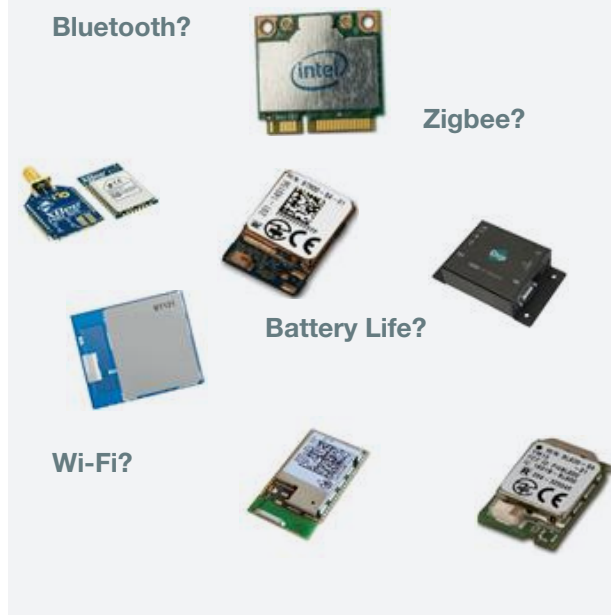

Choosing the wrong module could delay product development, so getting the right module the first time is critical. **Some factors to consider are:**

- > Cost / Develop versus Buy decision
- > Security
- > Wireless technology and protocol
- > Data throughput, Latency, connection setup speed
- > Network topology
- > Power consumption
- > Real Estate
- > Pre-certified or Non-pre-certified module selection
- > Future-proof & Long term availability
- > Robustness
- > Interchangeability
- > Vendor's application industry vertical focus, global presence, quality manufacturing, and support operations
- > Regulatory and Industry standards compliance/ qualifications requirements

4 Common Wireless Module Trade-Offs

No one wants to compromise on the design features that matter most, so it is important to balance trade-offs well. Here are four of the most common trade-offs and what they can mean for your design.

- 1. Module vs Reference Design**
- 2. Data Rate vs Range vs Power Requirements**
- 3. Robustness vs Interchangeability**
- 4. Cost vs Everything**

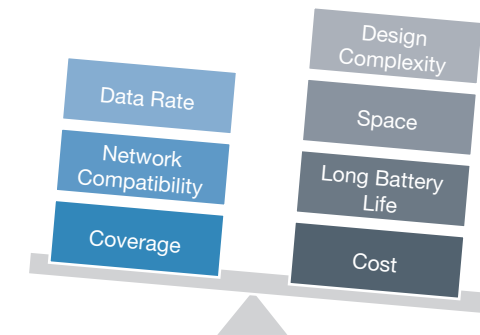

For more information visit tektronix.com/loT to download our tutorial **"Selecting the Right Wireless Module"**.



Challenge: 2

Designing and Debugging Complex Mixed Signal Devices (Analog, Digital, and RF)

Traditionally, radio devices for most applications would have been designed by highly experienced RF design engineers. Now there are countless radio “modules” that can be purchased and integrated into your project with reference designs. These modules are helping to fuel the huge boom in IoT devices and can speed along development time. However, when it comes time to system level troubleshooting, design teams struggle to figure out if the problem lies with their module or with their device. >>

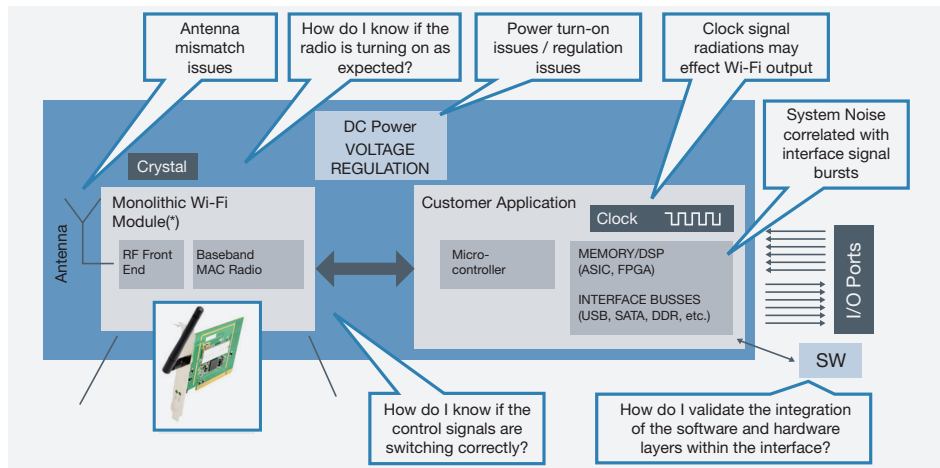

Example of an IoT device block diagram.

Trying to debug complex systems can be time consuming and costly without the right equipment and a test plan.

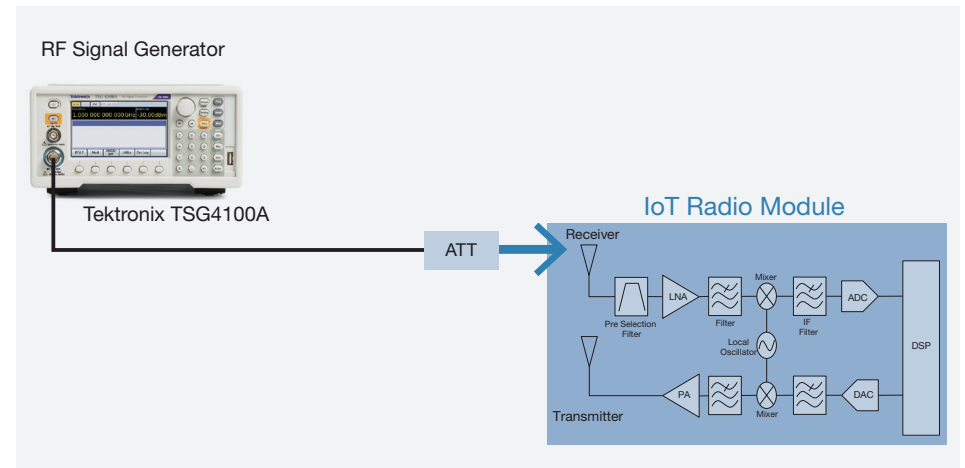

Test set up for Receiver Sensitivity.

The simplest way to test if your device is transmitting a signal is to use a Spectrum Analyser to visualize the RF signal. Measuring the signal's frequency and power level are easy when using the correct instruments. If you need to test how well that your radio receiver is working, sensitivity and blocking tests are your best bet. The sensitivity test is used to verify that the receiver is capable of operating with a minimum discernible signals. A receiver blocking test is the opposite in that it verifies that the device is capable of ignoring unwanted signals while still demodulating a desired signals. Each of these tests requires an RF Signal generator.

For more information visit tektronix.com/loT to download our tutorial “*Debug Digital/Analog/RF System Problems of IoT Devices*”.

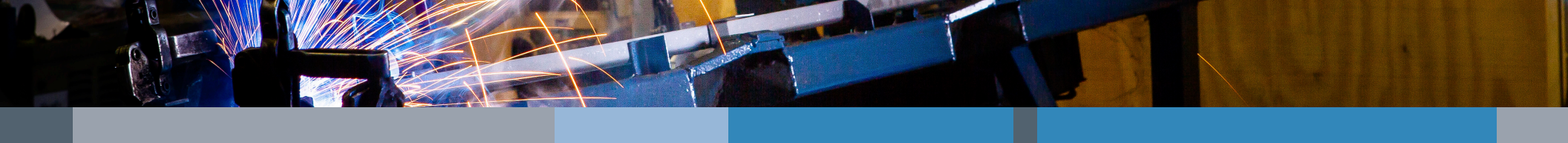

Accelerate your design with comprehensive solutions for debugging complex Digital, Analog and RF system problems

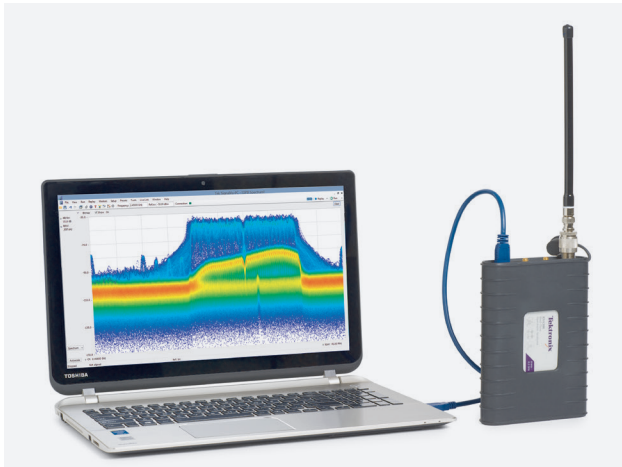

RSA306 USB Spectrum Analyzer and Signal-Vu PC

Ensure that your IoT device is transmitting at the correct power level and frequency.



TSG4100A RF Vector Signal Generator

Perform powerful functional and sensitivity tests on RF Receivers.



MDO4000B Mixed Domain Oscilloscope

Verify system level operation through correlation of correlating analog and digital signals with RF.

For more information visit tektronix.com/loT to download our tutorial *“Debug Digital/Analog/RF System Problems of IoT Devices”*.



Challenge: 3

Maximizing Battery Life

Power management is a primary concern in IoT design. The battery life of IoT devices varies greatly, from hours to years, depending on the application and its operating environment. In all cases, however, the ability to accurately describe the device's power consumption is essential. Robust power analysis helps designers identify opportunities to reduce energy consumed and optimize battery life. >>

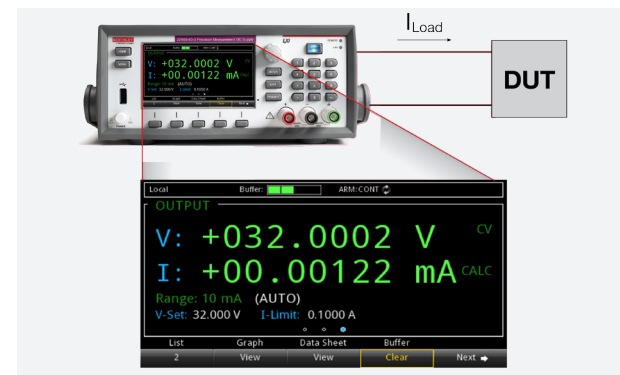
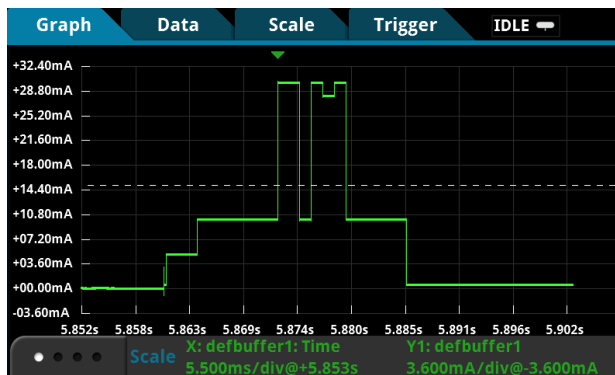
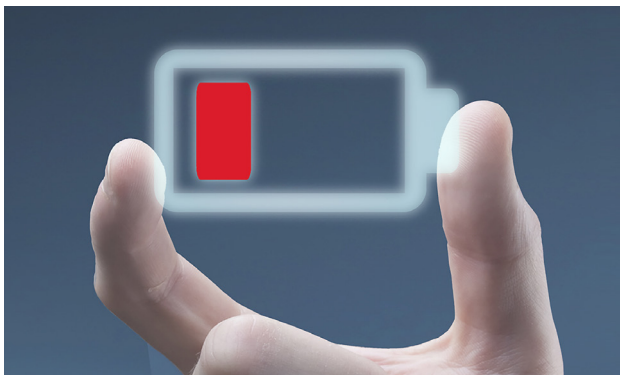

10 Power Analysis Measurement Challenges

A typical IoT device contains at least one sensor, a processor, and a radio chip that operates in different states and consumes currents from tens of nA to hundreds of mA in a matter of tens of microseconds. As a result, it is important to remember these challenges when choosing equipment to perform the analysis with.

1. Measuring a wide dynamic range of current levels
2. Determining ultra-low deep sleep current
3. Measuring transmit and receive current
4. Capturing short transients and fast transitions
5. Ensuring sufficient measurement bandwidth for your sample rate
6. Triggering to isolate specific events
7. Recording device operations over extended states
8. Analyzing power consumption from complex waveforms
9. Isolating device design issues from power source issues
10. Providing a stable voltage for all device operating conditions

For more information visit tektronix.com/loT to download our tutorial “11 Power Consumption Measurement Techniques”.

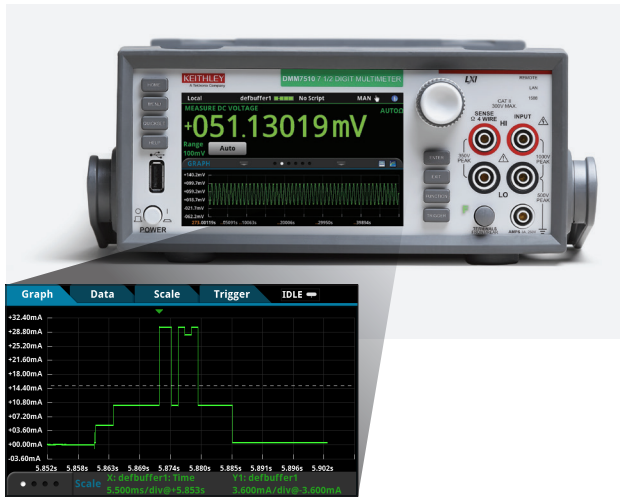

Tektronix DMM7510. Experience unprecedented signal analysis that will help you design more energy efficient devices. Featuring a touch screen display, for quick and intuitive navigation.

Maximize your mobile to mobile device's battery life

Accurately measure your IoT and M2M device's current draw and power consumption in active, standby and sleep modes.



Series 2281S with Battery Simulator. Create stable low noise voltage supply for every state of your IoT device, from sleep to transmit. Record and generate battery sources with the Battery Simulator option.

- > Very accurate low and high current sourcing and measurement (from nA to A) throughout the different stages of the radio.
- > DMM7510 has high resolution digitizer for accurate transient current measurements during changing modes
- > The 2281S Power Supply offers the same great features of the 2280S DC Power supply with additional battery recording and simulation functionality



Series 2280S. Delivers Analog and Advanced vector and digital modulation capabilities critical for EMI/EMC testing. Its flexible configuration offers CAPEX protection.

- > The 2281S Power Supply is essential when creating stable low noise voltage supply for every state of your IoT device, from sleep to transmit. Record and generate battery sources with its Battery Simulator option.
- > Create stable low noise voltage supply for every state of your IoT device, from sleep to transmit, with the linear, programmable, 2280S Power Supply.

For more information visit tektronix.com/loT to download our tutorial "11 Power Consumption Measurement Techniques".



Challenge: 4

Passing EMI and EMC Certification

The race to add products to the Internet of Things brings a degree of complexity to EMI testing. Not only do product manufacturers need to learn how to properly add a wireless capability to their product, but from an EMI perspective it requires additional intentional radiator testing. EMI regulations are in place throughout the world to provide improved reliability and safety for users of electrical and electronic equipment. >>

Compliance testing is exhaustive and time consuming, and a failure in EMI in the final stages of product development can cause expensive re-design and delay time to market. In addition, the full compliance test in a certificated lab can be expensive, with costs ranging from \$1,000 to \$3,000 per day.

Pre-compliance testing is commonly used to catch compliance problems early and greatly improve the probability of a successful first pass of full EMI compliance testing, thus effectively reducing your time-to-market. The test set up is relatively simple and, with the right equipment and planning, can be a valuable tool in troubleshooting your design.

With the Tektronix RSA306 USB based Real Time Spectrum Analyzer pre-compliance testing has never been easier or more cost effective.

(a) Radiated test setup

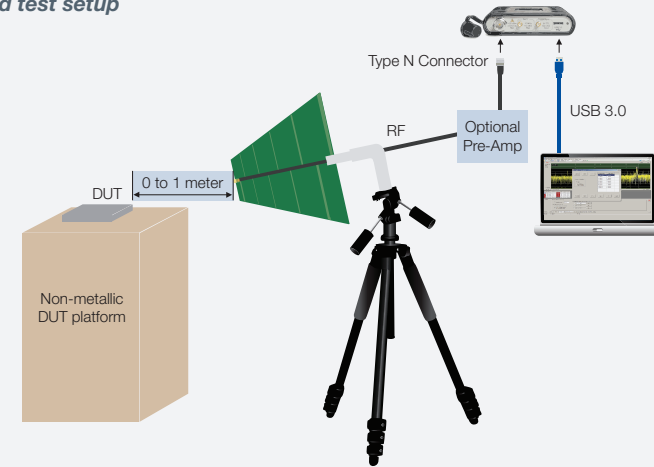

(b) Conducted test setup

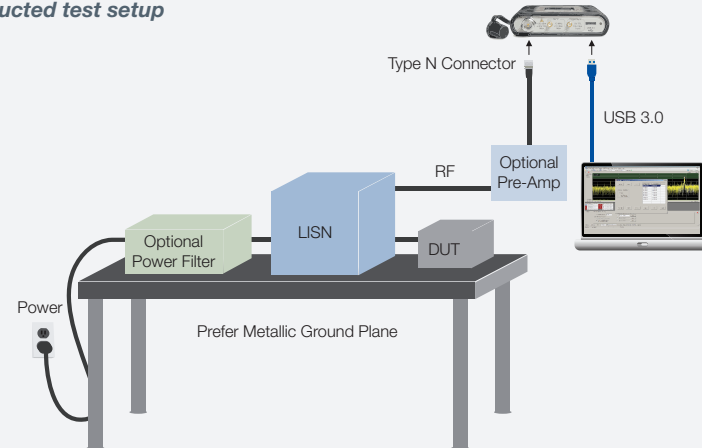

For more information visit tektronix.com/loT to download our tutorial “Don’t Let EMI/EMC Compliance Certification Slow You Down”.

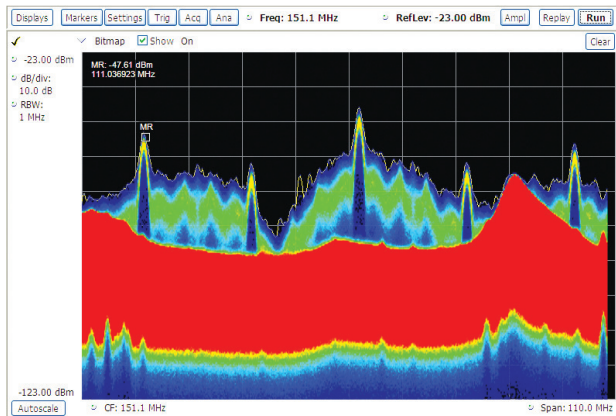

Digital Phosphor Processing (DPX) may be used to quickly discover intermittent problems.



Tektronix's MDO4000B Series offers a unique ability to view analog signal characteristics, digital timing, bus transactions, and frequency spectra synchronized together.

Periodicity and Coincidence

Are you seeking out the problem source or antenna at the heart of your EMI problem? Examining the Periodicity and the Coincidence of the signals can give you the clues to track it down.

Periodicity:

Analyzing the nature of the RF signal can help narrow down a list of possible sources. What is the RF frequency of the signal? Is it pulsed or continuous?

Coincidence:

Examining what signals occur or change simultaneously can help point to trigger events. What signal on the DUT coincides with the EMI event?

For more information visit tektronix.com/loT to download our tutorial “Don’t Let EMI/EMC Compliance Certification Slow You Down”.

Our EMI Solution

Don't Let EMI/EMC Compliance Certification
Slow You Down

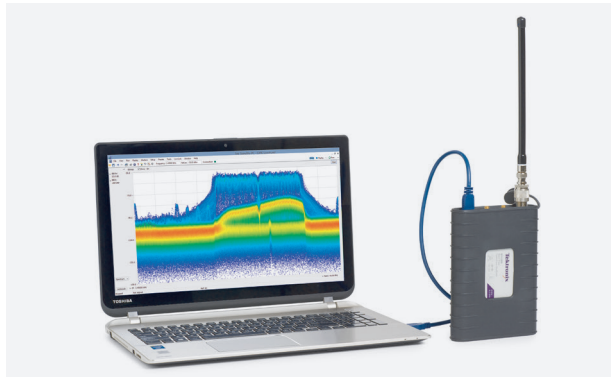

RSA306 USB Spectrum Analyzer with
Signal-Vu PC Software

**Faster EMC Pre-compliance without having to wait
for access to a lab**

- > Low cost & PC-based real time spectrum analyzer
- > Faster detection of short duration EMI signals with RSA306 DPX real-time technology and automated pre-compliance setups
- > Built in RF record/playback to easily capture and analyze EMI spectral events

Avoid EMI caused by intentional RF transmitters

- > Understand change in EMI signature due to intentional RF transmission
- > Correlate EMI events with RF transmission with using RSA306 on Spectrum Emission Mask and DPX



MDO4000B Mixed Domain Oscilloscope

Faster EMI Debugging and Troubleshooting

- > With MDO4000B's time correlation capability you pin point the noise source and avoid the painful and repetitive task of changing components.
- > Understand the root cause analog and/or digital signals that are causing the EMI noise.

For more information visit tektronix.com/loT to download our tutorial *"Don't Let EMI/EMC Compliance Certification Slow You Down"*.



Challenge: 5

Speeding Through Wireless Standards Certification

Wireless technology standards are needed to ensure that products can interoperate within the ecosystem where they will be deployed. There are a number of technologies to choose from, including Wi-Fi[®], Bluetooth[®], ZigBee[®]. However to adhere to the standard, new products will need to meet qualification as defined per the standard selected. Failing qualification can mean design turns that will delay the final product release and draw additional significant development cost. >>

Pre-testing for standard qualification is a cost-effective way to catch problems early, while there is time to correct issues without costly redesigns, delays, and retesting at the test house.

What does Standard Qualification mean?

Qualification is the term used to describe what tests a product is required to pass to meet a wireless standard. Qualification ensures the product will interoperate with other devices using the same wireless standard.

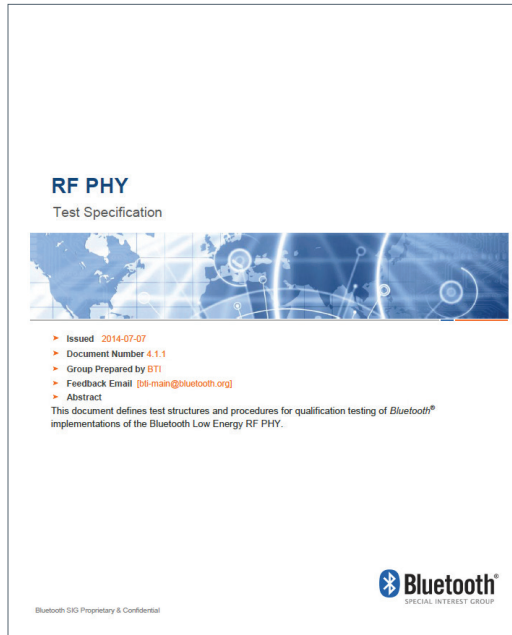

Bluetooth Fast Facts

- > Bluetooth SIG defines the process for granting the Bluetooth Logo to products.
- > Modules can also be qualified BTE products, but do not automatically qualify the device.
- > Reference design or Bluetooth profile changes need to be qualified with additional testing.



WiFi Fast Facts

- > To use the “Wi-Fi Certified” logo on products, firms must become members of the Wi-Fi Alliance.
- > Members submit their products for testing at Wi-Fi Alliance’s designated certification testing facilities.
- > The tests ensure the product meets specifications defined by the IEEE 802.11 standard committee.

For more information visit tektronix.com/loT to download our tutorial “Speeding Through Wireless Standards”.

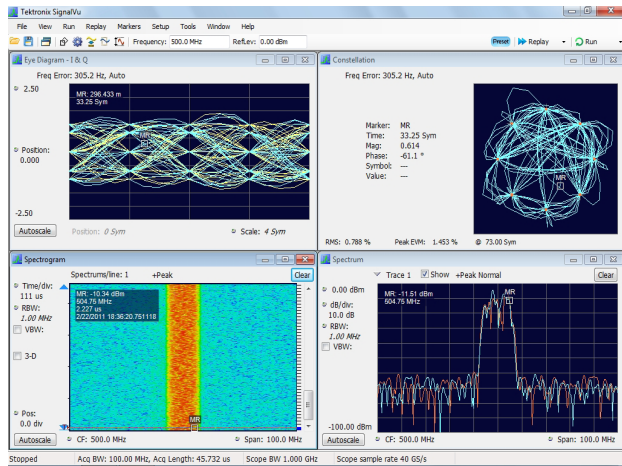

Signal-Vu PC Software.

Our Wireless Standards Solution

Get to market faster with compliance tests on RF transceivers with:



RSA306 USB Spectrum Analyzer.

- > Automatic standard signal detection
- > Bluetooth Low Energy and Basic Rate pre-certification
- > WLAN 802.11 pre-certification
- > Basic Rate and Enhanced Data Rate
- > Digital modulation analysis for RFID, ZigBee
- > Powerful and automated measurements
- > EVM, SEM, frequency error, symbol clock error
- > Displays for key modulation and RF measurements



MDO4000B Mixed Domain Oscilloscope.

- > Push-button measurements, pass/fail reporting, and customizable limits
- > Get the right form factor for field and lab use
- > Single User Interface supporting all signal acquisition hardware
- > Easy set up and data management
- > All setups and data remains on your PC

For more information visit tektronix.com/loT to download our tutorial *“Speeding Through Wireless Standards”*.



Challenge: 6

Combatting the Interference of Things

Over the past decade there has been a dramatic increase in the population of wireless transmitters found in the world. Arguably the spectrum in the 2.4 GHz is the most popular operating area for low-cost, license free applications and there are literally millions of radios operating in this frequency band. Utilizing license exempt spectrum is attractive because of the cost savings, but you get NO protection from all the other people using the same channels. >>

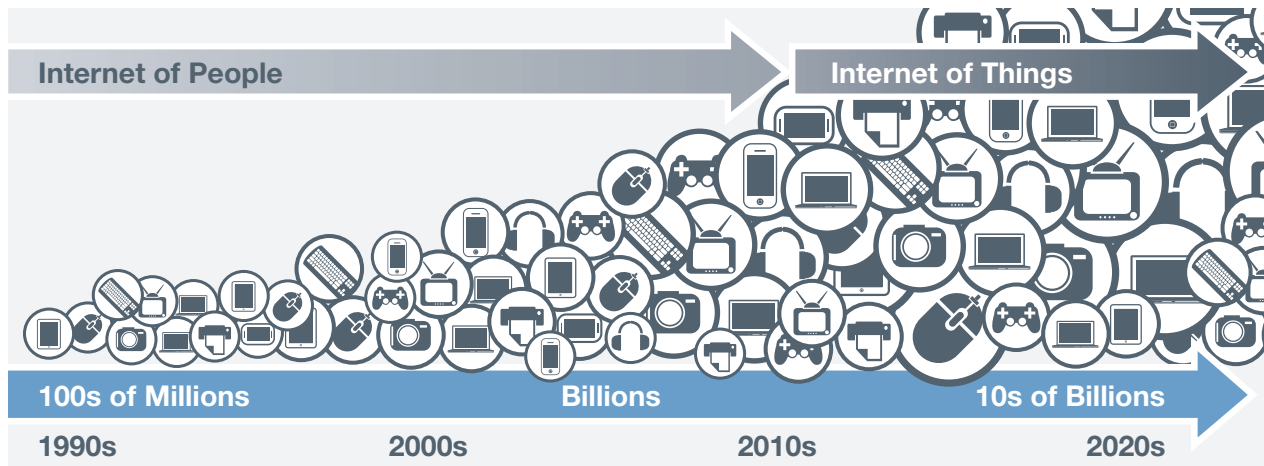
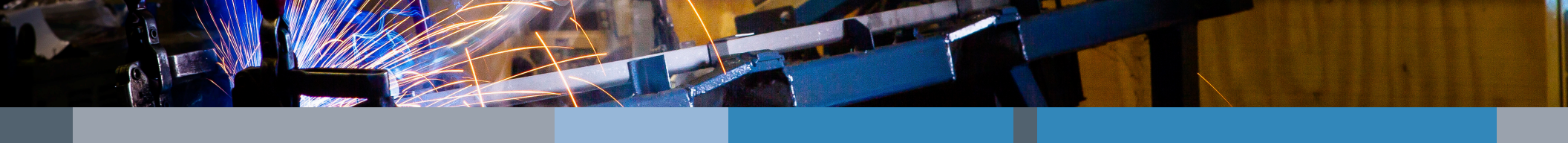

Cellular Network Operators employ teams who specialize in identifying and eliminating interference to maintain network quality. However, interference poses a unique challenge to device manufacturers as well. Engineers are finding that even when they use a “certified” solution, they are still having problems establishing a radio link and maintaining communications in the field. Diagnosing these problems with a real-time spectrum will help you characterize what’s happening to your device in the presence of all the other devices using the same spectrum.

What is Interference Hunting?

Interference hunting is the art/science of finding sources of RF interference within a network area and neutralizing its effects.

Interference hunting has become common practice with network providers. This trend is driven by a greater number of wireless network users expect high quality and reliable access.

Quick resolution of network issues requires field-ready tools that allow interference hunters to observe the RF spectrum in real time.

How To Troubleshoot A Radio Link

- 1. Characterize the Radio Link – Draw a picture of what “good” looks like using the radio specifications.*
- 2. Analyze the Radio Link in Real Time- View the signal in real time to look for anomalies.*
- 3. Characterize the RF Environment – See the complete picture by seeing how the signal interacts with others in its environment.*

Now that you can see the problem, you can get on with fixing it.

For more information visit tektronix.com/loT to download our tutorial “*Trouble-shooting Radio Links in Unlicensed Frequency Bands*”.

Combatting Interference

Interference Hunting made fast, easy and inexpensive for M2M connectivity in Factory Automation/ Industrial Process Control and Spectrum Management.

*RSA306 USB
Spectrum Analyzer.*

Field Friendly

- > Compact size but with bench class measurements in an easy to carry package
- > Weighs less than 1.0 kg so it's easy to carry around
- > Packed with all the features you expect in a portable spectrum analyzer

Spend Less Time Capturing and Locating Interfering Signals in heavily crowded frequency bands (WiFi, Bluetooth, ZigBee, Cellular)

- > Visualize, capture transients with real-time (DPX)
- > Easily test for transmitted and received power
- > Integrated spectrum logging
- > Mapping and direction finding features
- > Quickly, easily share results

Unmatched value in a portable spectrum analyzer

- > Fully-featured 3/7.5 GHz spectrum analyzer at \$3.4k
- > Field friendly and bench top models available
- > Free RF signal analysis software
- > Comprehensive warranty with worldwide support

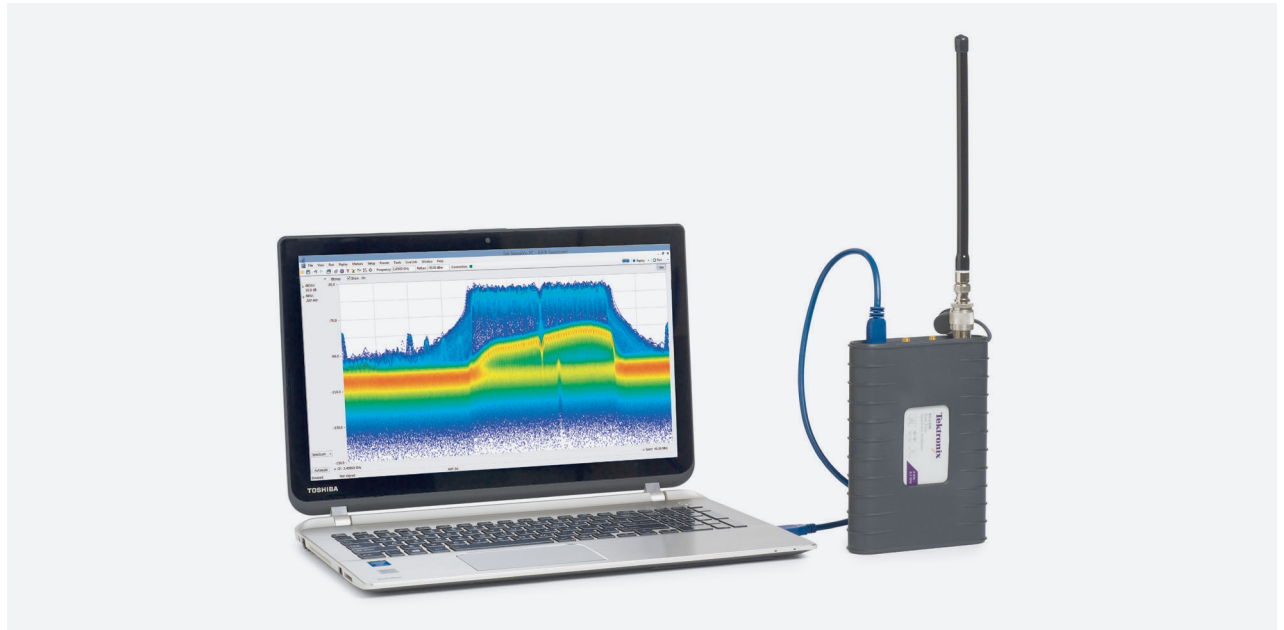

For more information visit tektronix.com/loT to download our tutorial *“Trouble-shooting Radio Links in Unlicensed Frequency Bands”*.

Conclusion

You're building the Internet of Things.
Together, we can build it better.

The Internet of Things is more than just a buzzword. It is an opportunity to create additional customer value through smart devices and analytics. To some teams building IoT devices, hardware is just the beginning. At Tektronix, we believe that hardware is the foundation upon which you build software and analytics capabilities. Overcoming the challenges presented in this eBook allows you to build that foundation to make Internet of Things even more resilient.

In this book, we've given a general overview of the six key challenges facing device makers when building devices with wireless communications and/or battery operation. More information on these topics can be found at tektronix.com/IoT, where you will find technical tutorials about each challenge. Articles, webinars, videos, blogs, and much more can be found at tektronix.com to support all of your electronic ventures.

Putting together an IoT ready test suite does not need to be expensive or difficult. Tektronix's offerings, which include instruments, software, and service, can cover all of your needs while still presenting tremendous value. To learn more about our solutions, access more educational resources, get in touch with one of our experts or request a quote, please visit tektronix.com. We are looking forward to partnering with you.

You're building the Internet of Things, Together we can build it better.

Learn more at tektronix.com/IoT.

References

- > **Bluetooth Poster**
www.tektronix.com/bluetooth
- > **WLAN Primer**
www.tektronix.com/wifi
- > **WLAN Poster**
www.tektronix.com/wifi
- > **WLAN Pre-compliance Testing Application Note**
www.tektronix.com/wifi
- > **How to Select Your Wi-Fi Module**
info.tektronix.com/www-how-select-your-wi-fi-module.html
- > **Convenient and cost-effective EMI pre-compliance testing blog**
www.tektronix.com/blog/convenient-and-cost-effective-emi-pre-compliance-testing
- > **Practical EMI Troubleshooting Application Note**
www.tektronix.com/document/application-note/practical-emi-troubleshooting
- > **Embedded Wireless Debug Made Easy with Tektronix MDO4000**
www.tektronix.com/blog/embedded-wireless-debug-made-easy-tektronix-mdo4000

Don't see what you're looking for here? Search our library at www.tektronix.com/downloads for more high quality technical content.

Contact Tektronix:

ASEAN / Australasia (65) 6356 3900
Austria 00800 2255 4835
Balkans, Israel, South Africa and other ISE Countries +41 52 675 3777
Belgium 00800 2255 4835
Brazil +55 (11) 3759 7627
Canada 1 800 833 9200
Central East Europe and the Baltics +41 52 675 3777
Central Europe & Greece +41 52 675 3777
Denmark +45 80 88 1401
Finland +41 52 675 3777
France 00800 2255 4835
Germany 00800 2255 4835
Hong Kong 400 820 5835
India 000 800 650 1835
Italy 00800 2255 4835
Japan 81 (3) 6714 3010
Luxembourg +41 52 675 3777
Mexico, Central/South America & Caribbean 52 (55) 56 04 50 90
Middle East, Asia, and North Africa +41 52 675 3777
The Netherlands 00800 2255 4835
Norway 800 16098
People's Republic of China 400 820 5835
Poland +41 52 675 3777
Portugal 80 08 12370
Republic of Korea 001 800 8255 2835
Russia & CIS +7 (495) 6647564
South Africa +41 52 675 3777
Spain 00800 2255 4835
Sweden 00800 2255 4835
Switzerland 00800 2255 4835
Taiwan 886 (2) 2656 6688
United Kingdom & Ireland 00800 2255 4835
USA 1 800 833 9200

Rev. 0415

For Further Information

Tektronix maintains a comprehensive, constantly expanding collection of application notes, technical briefs and other resources to help engineers working on the cutting edge of technology. Please visit www.tektronix.com and www.keithley.com.

Copyright © 2015, Tektronix. All rights reserved. Tektronix products are covered by U.S. and foreign patents, issued and pending. Information in this publication supersedes that in all previously published material. Specification and price change privileges reserved. TEKTRONIX and TEK are registered trademarks of Tektronix, Inc. All other trade names referenced are the service marks, trademarks or registered trademarks of their respective companies.