

LCR Pro1/Pro1 Plus

User Manual

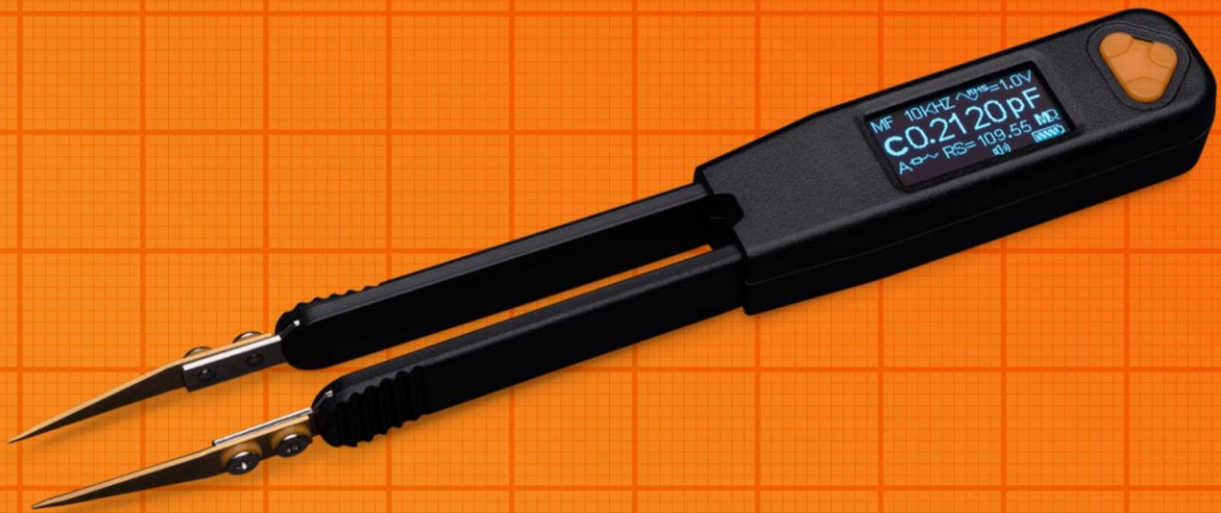

Notices

The information contained in this document is provided “as is,” and is subject to change, without notice, in future editions.

This document contains proprietary information that is protected by copyright. All rights are reserved. No part of this document may be photocopied, reproduced, or translated to another language without the prior agreement and written consent from LCR Research Ltd.

© LCR Research Ltd. 2016

Warranty

LCR Research warrants this product to be free from defects in materials and workmanship for a period of one (1) year from the shipment date. LCR Research warrants the following items for ninety (90) days from the date of shipment: rechargeable batteries, gold plated tips and documentation. During the warranty period, LCR Research will, at its option, either repair or replace products that prove to be defective. For warranty service or repair, this product must be returned to a service facility designated by LCR Research. The buyer shall prepay shipping charges to LCR Research, and LCR Research shall pay shipping charges to return the product to the buyer. However, the buyer shall pay all shipping charges, duties, and taxes for products returned to LCR Research from another country. Repaired or replaced products are warranted for the balance of the original warranty period.

Limitation of Warranty

This warranty does not cover normal wear and tear and scratches on surface or display. This warranty does not cover physical damage to the display, switch or button, electrical damage of the product due to high voltage or improper battery type. This warranty shall not apply to defects resulting from improper or inadequate maintenance by the buyer, buyer-supplied software or interfacing, unauthorized modification or misuse, operation outside the environmental specifications for the product, or improper site preparation or maintenance.

No other warranty is expressed or implied. LCR Research specifically disclaims the implied warranties of merchantability and fitness for a particular purpose. LCR Research shall not be liable for errors or for incidental or consequential damages in connection with the furnishing, use, or performance of this document or of any information contained herein.

Exclusive Remedies

The remedies provided herein are the Buyer’s sole and exclusive remedies. LCR Research shall not be liable for any direct, indirect, special, incidental, or consequential damages, whether based on contract, tort, or any other legal theory. Such excluded damages shall include, but are not limited to: costs of removal and installation, losses sustained as the result of injury to any person, or damage to property.

FCC Rules, Part 15.

This equipment has been tested and found to comply with the limits for a Class B digital device, pursuant to part 15 of the FCC Rules. These limits are designed to provide reasonable protection against harmful interference in a residential installation. This equipment generates, uses and can radiate radio frequency energy and, if not installed and used in accordance with the instructions, may cause harmful interference to radio communications. However, there is no guarantee that interference will not occur in a particular installation. If this equipment does cause harmful interference to radio or television reception, which can be determined by

turning the equipment off and on, the user is encouraged to try to correct the interference by one or more of the following measures:

- Reorient or relocate the receiving antenna.
- Increase the separation between the equipment and receiver.
- Connect the equipment into an outlet on a circuit different from that to which the receiver is connected.
- Consult the dealer or an experienced radio/TV technician for help.

This device complies with Part 15 of the FCC rules.

Operation is subject to the following two conditions:

- This device may not cause harmful interference.
- This device must accept any interference received, including interference that may cause undesired operation.

Changes or modifications not expressly approved by the party responsible for compliance could void the user's authority to operate the equipment.

Safety Notices

CAUTION

Cautions must be observed to avoid minor injury to yourself or damage to the product or other property.

WARNING

Warnings must be followed carefully to avoid personal injury or death or damage to the product or other property.

Safety Considerations

Read the information below before using this meter. This meter is intended for use by qualified personnel who recognize shock hazards and are familiar with the safety precautions required to avoid possible injury. The following general safety precautions must be observed during all phases of operation, service, and repair of this meter. Failure to comply with these precautions or with specific warnings elsewhere in this manual violates safety standards for design, manufacture, and intended use of the meter. LCR Research assumes no liability for the customer's failure to comply with these requirements.

CAUTION

- Disconnect circuit power and discharge all high-voltage capacitors before testing.
- When measuring in-circuit components, first de-energize the circuits before connecting them to the test tips.
- The battery must be charged by a computer USB port or a USB power adapter that provides output voltage DC 5V \pm 5%.
- This meter is for indoor use.

WARNING

- **Use this meter only as specified in this manual, otherwise, the protection provided by the meter may be impaired.**
- **Do not use the meter if it is damaged. Before you use the meter, inspect the case. Look for cracks or missing plastic.**
- **Inspect the test tip sleeves for damaged insulation or exposed metal. Check the test tips for continuity. Replace damaged test tip sleeves before you use the meter.**
- **Do not touch exposed metal in measurement. Keep your fingers on insulated test tip sleeves.**
- **Do not use the meter if it operates abnormally.**
- **Do not operate the meter around explosive gas, vapor, or in wet environments.**
- **Never use the meter in wet conditions or when there is water on the surface. If the meter is wet, ensure that the meter is dried only by trained personnel.**
- **When servicing the meter, use only the specified replacement parts.**
- **Do not attempt to replace the internal lithium-ion polymer battery yourself. You may damage the battery, which could cause overheating and injury. The battery should be replaced only by a LCR Research Authorized Service Provider, and must be recycled or disposed of separately from household waste. Don't incinerate the battery.**
- **Do not use damaged cables or chargers, or charge when moisture is present. It can cause fire, electric shock, injury, or damage to the product or other property.**

Contents

1. Overview

| | |
|---|---|
| Product Introduction..... | 1 |
| Features and Functions..... | 1 |
| The Navigation Button..... | 1 |
| Turn On the Meter..... | 2 |
| Power Off..... | 2 |
| Switching to Menu Screen from Measurement Screen..... | 2 |
| Charging the Battery..... | 3 |
| Battery Level Indicator..... | 3 |
| Display..... | 4 |
| Connecting to PC..... | 6 |
| Reset the Meter..... | 7 |
| Cleaning the Meter..... | 7 |

2. Setting Up Menus

| | |
|-------------------------------|----|
| Menu Structure..... | 8 |
| Navigating Menus..... | 8 |
| Main Menu..... | 9 |
| Autoset..... | 9 |
| System Menu..... | 9 |
| System Autoset..... | 10 |
| Display Menu..... | 10 |
| Sound Menu..... | 11 |
| Timeout Menu..... | 12 |
| Test Speed Menu..... | 12 |
| Self-Calibration..... | 13 |
| Info Menu..... | 14 |
| Measurement Menu..... | 15 |
| LCRZ Menu..... | 16 |
| Secondary Parameter Menu..... | 16 |
| Sorting Menu..... | 17 |
| Recording Menu..... | 17 |
| Test Parameters Menu..... | 18 |
| Parameter Autoset..... | 18 |
| Test Frequency Menu..... | 18 |
| Test Voltage Menu..... | 19 |
| Circuit Mode Menu..... | 19 |
| Phase Angle Menu..... | 19 |
| Set Continuity Menu..... | 20 |

| | |
|--|----|
| Sorting Tolerance Menu..... | 21 |
| Sorting Reference Menu..... | 21 |
| Viewing Sorting Reference Values..... | 22 |
| Typing in a New Sorting Reference Value..... | 22 |

3. Making Measurements

| | |
|-------------------------------------|----|
| LCRZ Measurement..... | 24 |
| Auto Mode | 26 |
| Measuring Resistance (R) | 26 |
| Measuring Inductance (L)..... | 27 |
| Measuring Capacitance (C) | 27 |
| Measuring Impedance (Z)..... | 28 |
| Selecting Secondary Parameters..... | 28 |
| Selecting Circuit Mode..... | 29 |
| Selecting Test Frequency..... | 29 |
| Selecting Test Voltage..... | 29 |
| ESR Measurement..... | 30 |
| DCR Measurement..... | 30 |
| Diode Measurement..... | 31 |
| Continuity Measurement..... | 32 |
| Sorting Mode..... | 33 |
| Recording Mode..... | 35 |
| Holding the Display..... | 36 |

4. Characteristics and Specifications

| | |
|--|----|
| Product Characteristics..... | 37 |
| Electrical Specifications | 38 |
| Testing Signal Specifications..... | 38 |
| Measurement Ranges and Optimal Testing Frequency | 38 |
| Resistance Accuracy Specifications..... | 39 |
| Inductance Accuracy Specifications | 40 |
| Capacitance Accuracy Specifications..... | 41 |
| LED Testing Accuracy Specifications..... | 42 |

Overview

This chapter provides the basic operation procedures and describes names and functions on the display.

Product Introduction

LCR Pro1/Pro1 Plus ("the meter") is a portable impedance measuring device for incoming inspection of components, quality control, and laboratory use.

It is capable of measuring resistance, capacitance or inductance with 5 test frequencies (100Hz, 120Hz, 1 kHz, 10kHz and 100kHz). It has a basic accuracy better than 0.1% for resistance and 0.2% for capacitance and inductance measurements.

The meter has a pair of gold plated tips that can pick the SMD components with size down to 01005 (0.4mm x 0.2mm). The parasitic parameters of its probes are small and very predictable thanks to its unique mechanical design. It significantly reduces the probability of measurement errors related to setup (such as wires, probes, tips).

Features and Functions

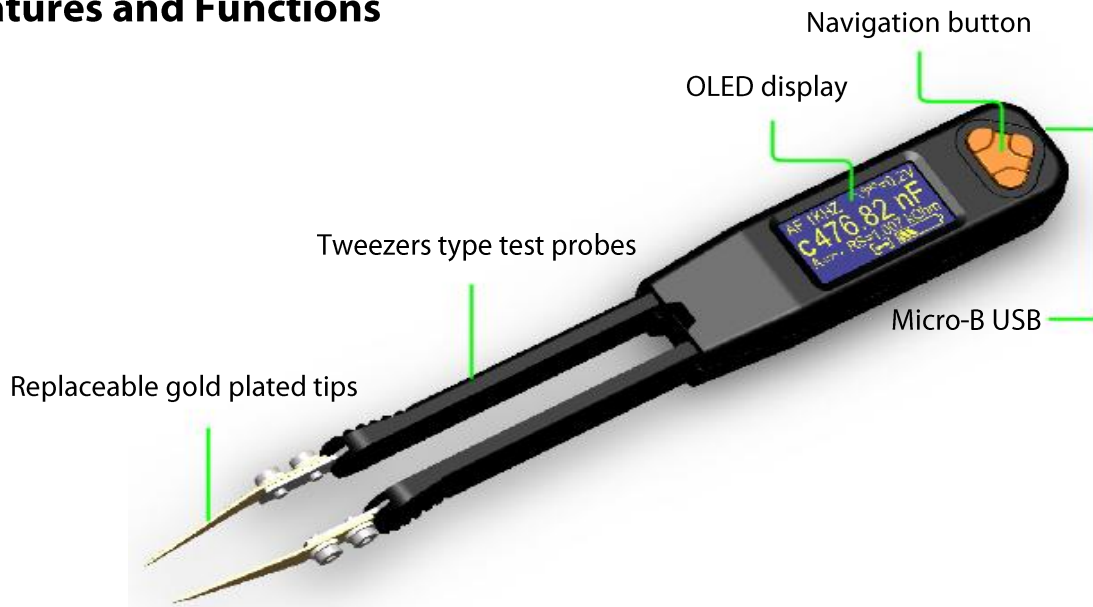

Figure 1-1: LCR Pro1/Pro1 Plus Overview

The Navigation Button

The navigation button is used to browse and select different functions and parameters. It includes the "Up", "Down" and "Select" buttons as Figure 1-2 shows.

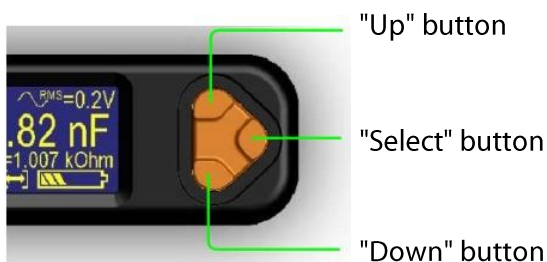

Figure 1-2: Navigation Button

The navigation button can be used for shortcut operation as well. Therefore, user can switch settings quickly in the measurement display and doesn't need to go back and forth between the menu display and measurement display. Detailed information is provided in Chapter 3: Making Measurements.

NOTE

When it switches from right hand operation to left hand operation, the "Up" and "Down" buttons are switched position as well.

Turn On the Meter

To power on the meter, press the "Select" button once. The meter powers up with the most recently selected measurement function.

Power Off

There are two ways to power off the meter:

1. Automatic power off. The meter powers off automatically if neither a measurement is performed nor any button is clicked during the timeout period. To change timeout setting, please go to main menu -> System -> Timeout. (Please refer to page 12: Timeout for the available options.)
2. Manual power off by selecting the turn off option from main menu as Figure 1-3 shows.



Figure 1-3: Turning off Display

NOTE

If test frequency is manually set to 10kHz or 100kHz, automatic power off may take longer to occur or not occur at all. This is due to the meter being more sensitive at 10kHz or 100kHz. It may see parasitic values and keep measuring even when the tips are open.

Switching to Menu Screen from Measurement Screen

When the meter is in measurement mode, user can switch it to menu screen by pressing down the "Select" button for half second or so until the main menu screen shows up. Figure 1-4 shows the meter goes to main menu screen from active mode (measuring components). Figure 1-5 shows the meter goes to main menu screen from idle mode (not measuring any component in measurement mode).

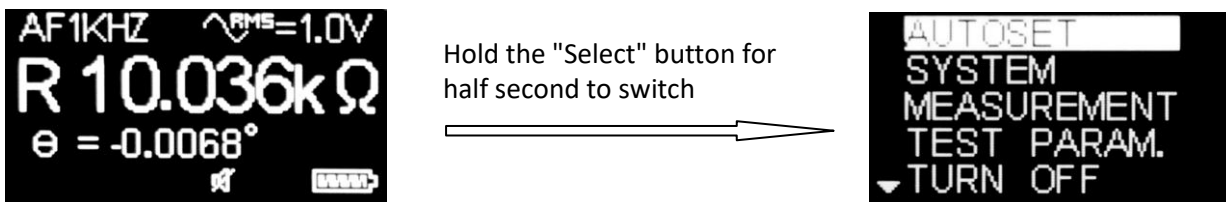

Figure 1-4: Switching from Measurement Display (in Active Mode) to Main Menu Display

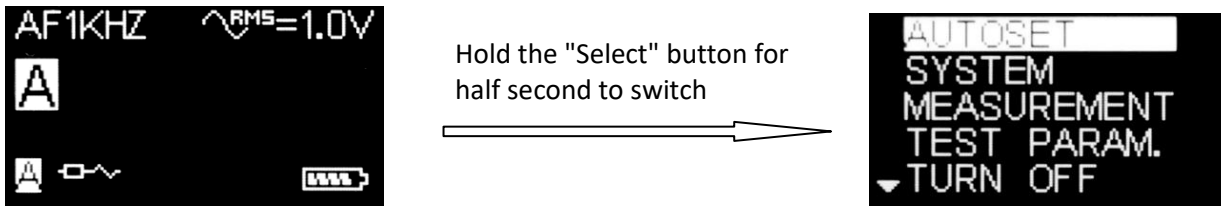

Figure 1-5: Switching from Measurement Display (in Idle Mode) to Main Menu Display

Charging the Battery

The meter is powered by an internal, lithium-ion polymer rechargeable battery. It can be charged by connecting to a computer USB port using a standard micro-B USB cable or, by using a USB power adapter. The USB power adapter should have output voltage 5V +/- 5% with output current 100mA or greater. The USB power adapter is available separately.

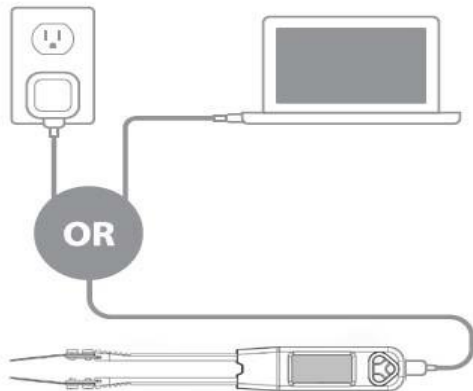

Figure 1-6: Charging the Meter

Battery Level Indicator

The battery icon in the bottom-right corner shows the battery level or charging status.

When the battery icon becomes hollow, it indicates that the battery remaining capacity is low and that it should be recharged. The warning appears when the battery capacity is about 95% depleted. The unit is still operational for a while, however the battery should be recharged as soon as possible.



Full Capacity

Empty Battery

Figure 1-7: Battery Charging Icon

CAUTION

Rechargeable batteries have a limited number of charge cycles and may eventually need to be replaced. The meter battery isn't user replaceable; it can be replaced only by a LCR Research Authorized Service Provider.

Display

This section describes the names and functions of parts on the meter display.











Figure 1-8: Measurement Display

The general display indicators of the meter are described in Table 1-1 below. Each display indicator is described. Please select the respective “Learn More On” page for more information on each indicator.

Table 1-1 General Display Indicators

| Indicator | Description | Learn More On: |
|-----------|--|-------------------------|
| A | Auto mode indicator, the meter selects R, L C automatically according to the component under test. | Page 26 |
| R | Resistance measurement indicator | Page 26 |
| Ls | Inductance measurement indicator in series circuit mode | Page 27 |
| Lp | Inductance measurement indicator in parallel circuit mode | Page 27 |
| Cs | Capacitance measurement indicator in series circuit mode | Page 27 |
| Cp | Capacitance measurement indicator in parallel circuit mode | Page 27 |
| Z | Impedance measurement indicator | Page 28 |
| | ESR (Equivalent Series Resistance) indicator | Page 30 |
| | DCR (Direct Current Resistance) indicator | Page 30 |
| | Auto circuit mode, the meter selects series mode for measurement. | Page 29 |
| | Auto circuit mode, the meter selects parallel mode for measurement. | Page 29 |
| | Manual circuit mode in series mode | Page 29 |
| | Manual circuit mode in parallel mode | Page 29 |
| Rs | Series resistance indicator | Page 28 |
| Rp | Parallel resistance indicator | Page 28 |
| D | Dissipation factor indicator | Page 28 |
| Q | Quality factor indicator | Page 28 |
| θ | Phase angle of impedance indicator | Page 26 |
| AF | Auto select test frequency | Page 29 |
| MF | Manual select test frequency | Page 29 |
| 100HZ | Test frequency at 100Hz | Page 29 |

Table 1-1 (continued from previous page)

| Indicator | Description | Learn More On: |
|---|--|----------------------------------|
| 120HZ | Test frequency at 120Hz | Page 29 |
| 1KHZ | Test frequency at 1kHz | Page 29 |
| 10KHZ | Test frequency at 10kHz | Page 29 |
| 100KHZ | Test frequency at 100kHz | Page 29 |
| 0.2V | Test voltage at 0.2Vrms | Page 29 |
| 0.5V | Test voltage at 0.5Vrms | Page 29 |
| 1.0V | Test voltage at 1.0Vrms | Page 29 |
| DC=1.0V | Test voltage at DC 1.0V | Page 30 |
| REF | Reference value in sorting mode | Page 22 |
| CONT. | Continuity mode | Page 31 |
| MAX | Maximum value in recording mode | Page 34 |
| MIN | Minimum value in recording mode | Page 34 |
| AV | Average value in recording mode | Page 34 |
| CNT | Count the measurement cycles in recording mode | Page 34 |
| Hold | Data hold mode indicator | Page 34 |
|  | USB data communication indicator | Page 6 |
|  | Sound on indicator | Page 11 |
|  | Sound off indicator | Page 11 |
|  | Battery capacity indicator | Page 3 |
|  | Good diode indicator | Page 31 |
|  | Damaged diode indicator | Page 31 |
|  | Up button indicator | Page 22, Page 31 |
|  | Down button indicator | Page 22, Page 31 |
|  | Select button indicator | Page 22 |

The units listed below are applicable to the primary display measurements of the meter.

Table 1-2 Display of Measurement Units

| Legend | Description |
|---------------|---|
| M | mega 1E+06 (1000000) |
| K | kilo 1E+03 (1000) |
| m | milli 1E-03 (0.001) |
| u | micro 1E-06 (0.000001) |
| n | nano 1E-09 (0.000000001) |
| p | pico 1E-12 (0.000000000001) |
| ° | Degree, unit for phase angle measurement |
| % | Percentage, unit for tolerance measurement |
| H | Henry, units for inductance measurement |
| F | Farad, units for capacitance measurement |
| Ω | Ohm, units for resistance and impedance measurement |

Connecting to PC

When the meter is connected to a PC via LCR Link1, it can be controlled remotely by the LCR Data Logger software.

The LCR Link1 is a dongle style communication module that links the meter to PC. It uses a fully integrated isolation technology to transfer data and charge the meter. This technology prevents PC noise interference so that the meter's performance and accuracy do not degrade when it is connected to PC.

The LCR Data Logger software can be used not only to configure the meter settings and parameters but also to log the data to an Excel spreadsheet. It also provides some unique functions, such as:

- Data Filter: Set a threshold to prevent undesired data from being logged due to bad contact, switching components, etc.
- Multi-component identification: The device performs step by step measurement on several components. User doesn't need to switch parameters manually when switching from one component to another. The device automatically sets the parameters according to the programming. It records the results and reports Pass or Fail.

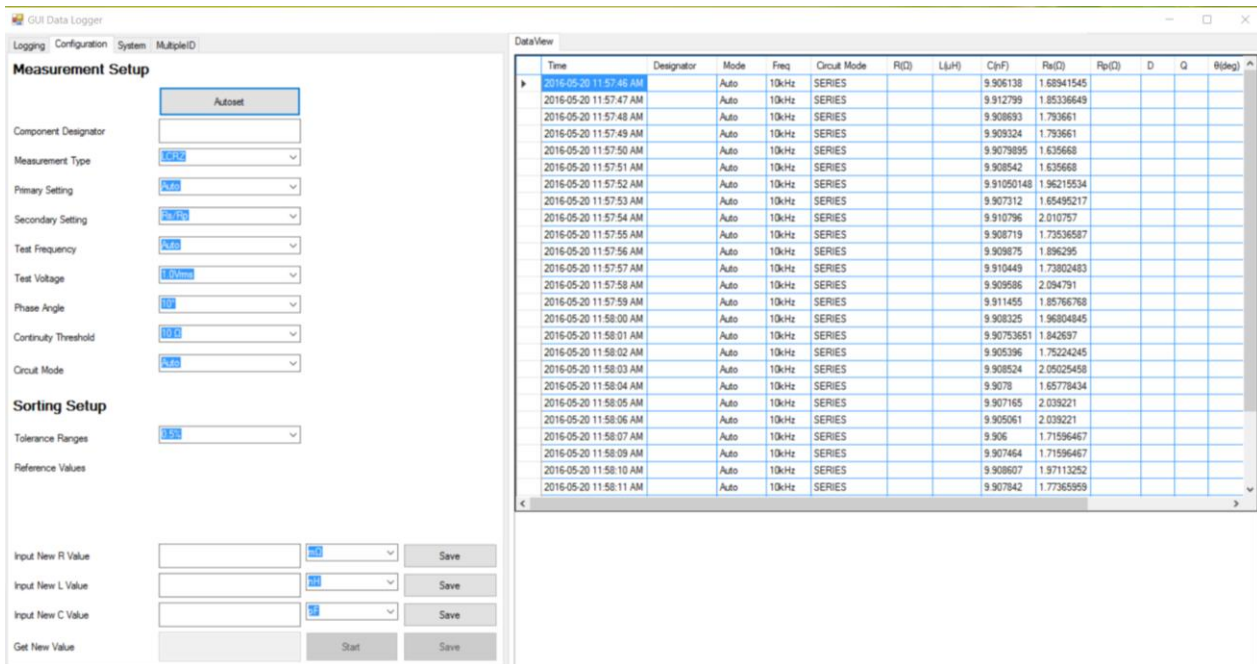

Figure 1-9: Snapshot of the LCR Data Logger Software

Refer to the user manual of LCR Data Logger Software for more information on the LCR Link1 communication module and the LCR Data Logger software.

The LCR Link1 is an aftermarket accessory that can be purchased separately. The LCR Data Logger software and its user manual are available for free download at <http://www.lcrresearch.com>.

Reset the Meter

The hardware reset function can reset the meter to factory original settings no matter which mode it is currently in. To perform hardware reset, just press down both "Up" and "Down" buttons for more than 10 seconds until the display is off. Releasing both buttons will reboot the meter.

NOTE

After the meter is reset, all the self-calibration data will be removed. Please perform self-calibration again if necessary.

Cleaning the Meter

WARNING

To avoid electrical shock or damage to the meter, always keep the insides of the casing dry.

Dirt or moisture on the tips can affect measurement accuracy. Follow the steps below to clean the tips and case.

1. Shake out any dirt that may be on the tips.
2. Wipe the tips with a clean swab dipped in alcohol.
3. Wipe the case with a damp cloth and mild detergent.

NOTE

Do not use abrasives or solvents when cleaning the meter.

Setting Up Menus

This chapter describes how to set up menu items and parameters.

Menu Structure

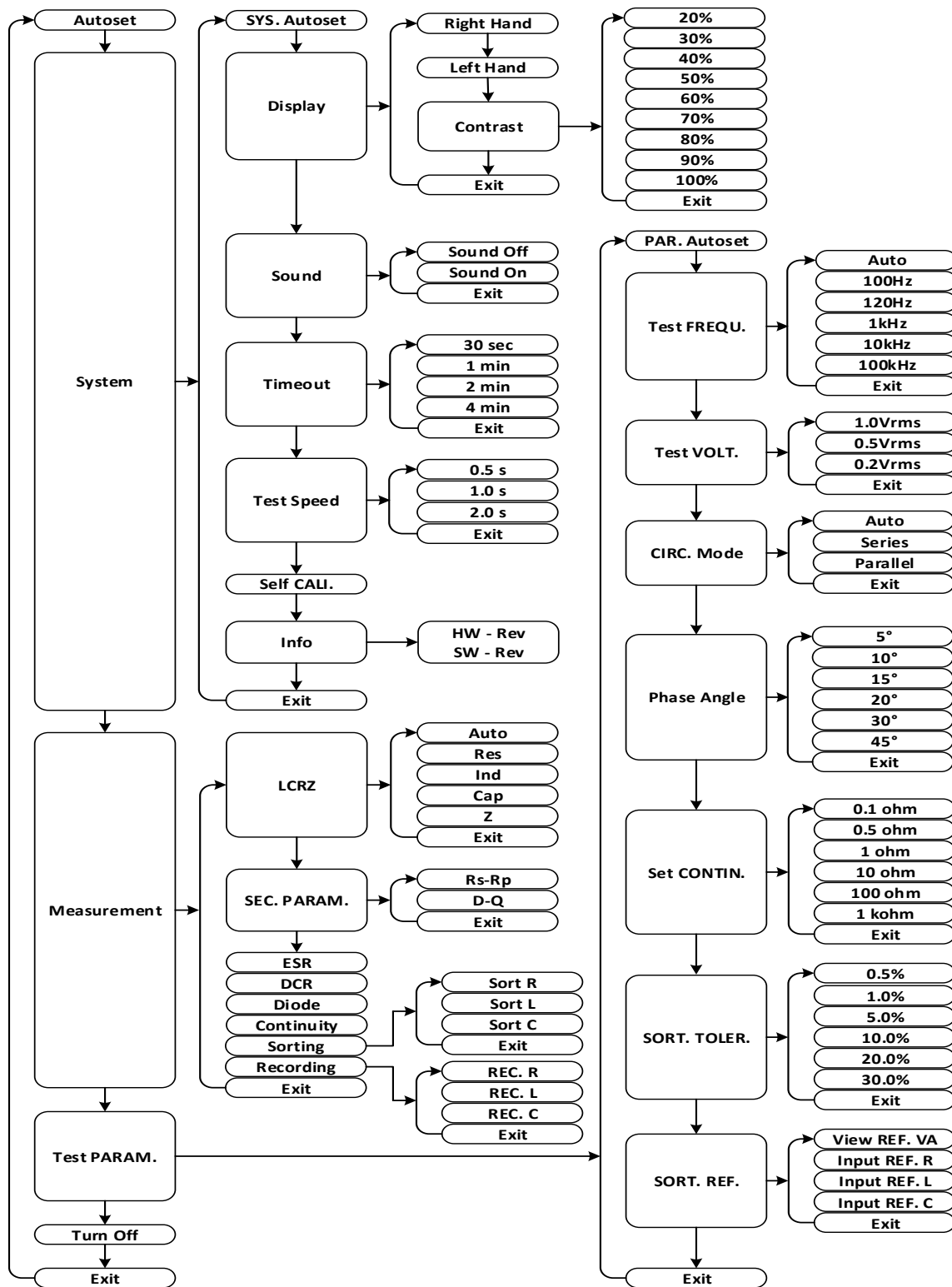

Figure 2-1: Menu Structure Flowchart

Navigating Menus

Press the “Up” or “Down” button to move cursor to the desired menu item and press the “Select” button to select it. The item that is highlighted indicates the current setting.

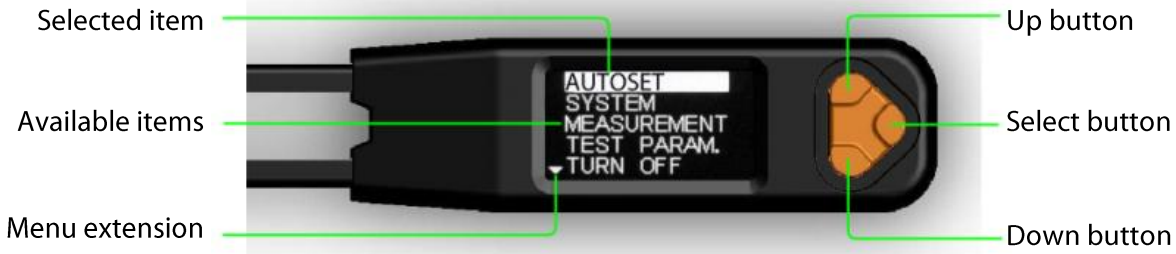

Figure 2-2: Navigating Menus

Main Menu

Main menu provides 5 options as described in Table 2-1.

Table 2-1 Description of Main Menu

| Menu Item | Description | Learn More On: |
|-------------|---|-------------------------|
| Autoset | Reset all the settings to default | Page 9 |
| System | Select user interface, start self-calibration and view device information | Page 10 |
| Measurement | Select measurement types | Page 15 |
| Test PARAM. | Select test parameters | Page 18 |
| Turn Off | Turn off the meter | Page 2 |
| Exit | Return to the measurement display | |

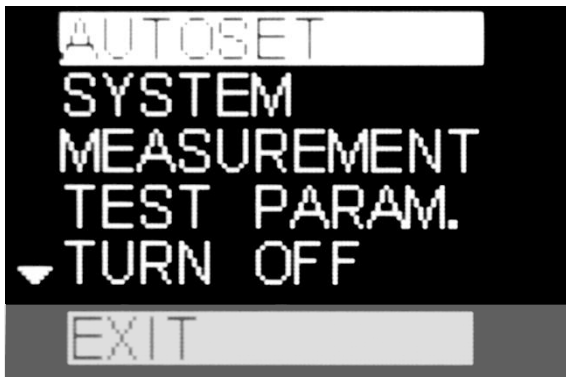

Figure 2-3: Main Menu

Autoset

Once Autoset is selected, the meter resets the following parameters to default:

- Measurement:
 - LCRZ: Auto
 - Secondary Parameters: Rs/Rp
- Test Parameters:
 - Test Frequency: Auto
 - Test Voltage: 1.0Vrms
 - Circuit Mode: Auto
 - Phase Angle: 10°

System Menu

8 items can be selected in system menu as described in Table 2-2.

Table 2-2 Description of System Menu

| Menu Item | Description | Learn More On: |
|--------------|--|-------------------------|
| SYS. Autoset | Reset all the settings to default in the system menu. | Page 10 |
| Display | Select left/right hand operation and adjust display contrast. | Page 10 |
| Sound | Turn on/off sound. | Page 11 |
| Timeout | Select the timer to power off the meter automatically. | Page 12 |
| Test Speed | Define how fast the meter measures the component under test and update the reading on display. | Page 12 |
| Self CALI. | Start short and open calibration. | Page 13 |
| Info | Provide the device information including serial number, hardware and software version. | Page 15 |
| Exit | Return to the measurement display. | |



Figure 2-4: System Menu

System Autoset

System Autoset is used to reset the following system parameters to default:

- Display
 - Right Hand
 - 40% Contrast
- Sound: On
- Timeout: 1min
- Test Speed: 1.0sec

Display Menu

Display menu is used to select display settings. The default setting is right hand with 40% contrast. The Display menu has 4 options as Figure 2-5 shows:

- Right Hand: select the right hand operation mode.
- Left Hand: select the left hand operation mode.
- Contrast: change the display contrast settings.
- Exit: Return to the measurement display.



Figure 2-5: Display Menu

Contrast menu is used to adjust the display contrast. The following values can be selected from the darkest 20% to the brightest 100%:

- 20%
- 30%
- 40%
- 50%
- 60%
- 70%
- 80%
- 90%
- 100%
- Exit: Return to the measurement display.

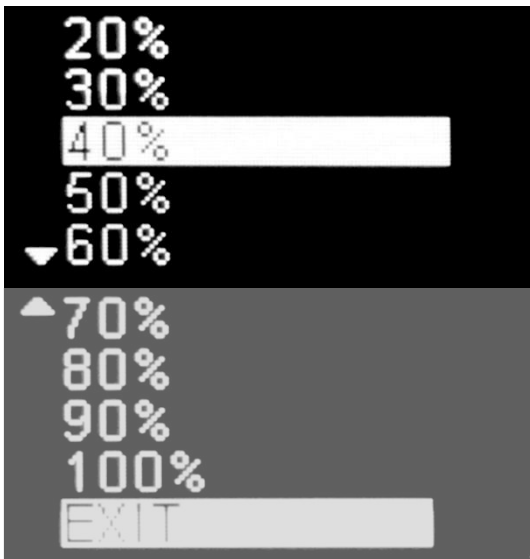

Figure 2-6: Contrast Menu

Sound Menu

Sound menu is used to turn sound on and off. The default setting is On. The Sound menu has 3 options as Figure 2-7 shows:

- Sound On: turn on sound.
- Sound Off: turn off sound.
- Exit: Return to the measurement display.



Figure 2-7: Sound Menu

Timeout Menu

Timeout menu is used to select the timer to powers off the meter automatically if neither a measurement is performed nor any button is clicked. The default setting is 1 minute and the following timeout values can be selected:

- 30sec
- 1min
- 2min
- 4min
- Exit: Return to the measurement display.



Figure 2-8: Timeout Menu

Test Speed Menu

Test speed menu is used to select how fast the meter measures the component under test. The default setting is 1.0 second per measurement and the following test speeds can be selected:

- 0.5sec
- 1.0sec
- 2.0sec
- Exit: Return to the measurement display.

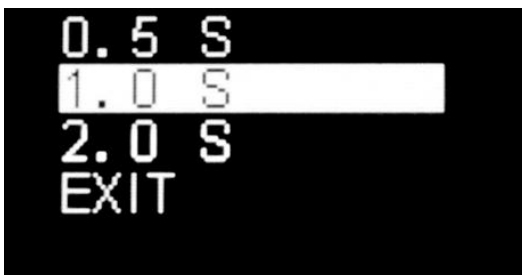

Figure 2-9: Test Speed Menu

NOTE

The faster the test speed, the shorter the battery life as the meter works in active mode more often to perform more measurements.

Self-Calibration

The self-calibration includes short and open calibration. It offsets the meter's internal and external parasitic parameters for better accuracy. Performing this action will help the user correct the influence for temporary uses.

Table 2-3 describes how to set up the meter to self-calibration.

Table 2-3: Set Up Self-Calibration

| Settings | Menu Structure |
|------------------|---|
| Self-Calibration | Main Menu -> System -> Self-Calibration |

In self-calibration mode, the step by step instructions are shown on the display. Follow these instructions to perform the short/open calibration:

1. When self-calibration is selected, Figure 2-11 shows on the display. Please shorten 2 tips and press any button to start the short calibration.



Figure 2-10: Start Short Calibration

2. Once any button is pressed, Figure 2-12 shows on the display indicating short calibration is in progress.

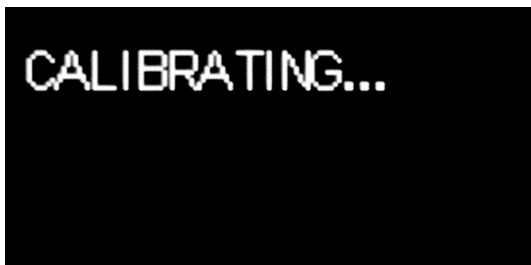

Figure 2-11 Calibration in Progress

3. After a couple of seconds, the short calibration is completed. Figure 2-12 shows on the display. Please keep the tips open and press any button to start the open calibration.



Figure 2-12: Start Open Calibration

- Once any button is pressed, Figure 2-13 shows on the display indicating open calibration is in progress.

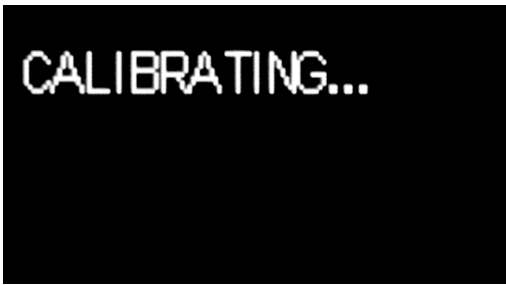

Figure 2-13: Calibration in Progress

- After a couple of seconds, the open calibration is completed. If the result is good, a calibration done message will be shown on the display indicating the whole self-calibration process is completed. Please press any button to return to the measurement mode.

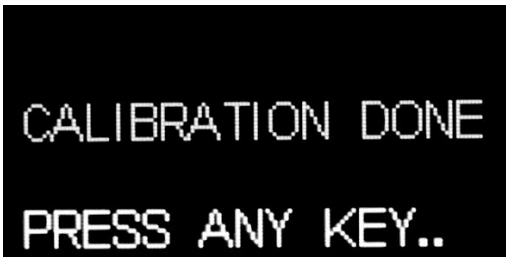

Figure 2-14: Calibration Completed

- If the result is out of range, a fail message will be on the display as Figure 2-15 shows. Please press any button to return to the measurement mode. If necessary, please start the self-calibration process again from the beginning.



Figure 2-15: Calibration Failed

NOTE

- It is recommended that the user performs open/short calibration before making precision measurements.
- When doing short calibration, please always keep the tips shorted firmly. The calibration process may fail if the tips are in poor contact condition during the short calibration process.
- The distance between the tips creates small parasitic capacitance. When such distance varies (i.e. measuring components with different sizes), the parasitic capacitance varies as well. Therefore, when doing open calibration, please keep the tip distance as close as possible to the actual size of the component to be measured. It can compensate for the parasitic capacitance most accurately.
- After the battery is completely dead or hardware reset is performed, all the self-calibration data will be removed. Please perform self-calibration again if necessary.

Info Menu

The following device information has been provided in the Info menu:

- HW Version: it provides the device hardware version.
- SW Version: it provides the device software version.



Figure 2-16: Info Menu

Measurement Menu

8 items can be selected in Measurement menu as described in Table 2-4.

Table 2-4 Description of Measurement Menu

| Menu Item | Description | Learn More On: |
|-------------|---|----------------------------------|
| LCRZ | Measure inductance (L), capacitance (C), resistance (R) or impedance (Z). | Page 16, Page 24 |
| SEC. PARAM. | Select the secondary parameter to be displayed. | Page 16, Page 28 |
| ESR | Measure the equivalent series resistance (ESR) of a capacitor, independent of its capacitance. | Page 30 |
| DCR | Measure the resistance of an unknown component by direct current resistance (DCR) mode. | Page 30 |
| Diode | Test diode polarity or indicate a faulty diode if it sees short/open conditions. | Page 31 |
| Continuity | Test whether the component under test is electrically connected. | Page 31 |
| Sorting | Sort the component according to the preset tolerance. | Page 17, Page 32 |
| Recording | Record the maximum, minimum, average result and measurement cycles during a series of measurements. | Page 17, Page 34 |
| Exit | Return to the measurement display | |



Figure 2-17: Measurement Menu

LCRZ Menu

The following settings can be selected in LCRZ menu and the default setting is Auto.

- Auto: the meter automatically identifies the component under test (L, C or R).
- R: measure resistance.
- L: measure inductance.
- C: measure capacitance.
- Z: measure impedance.
- Exit: Return to the measurement display.



Figure 2-18: LCRZ Menu

Secondary Parameter Menu

The following settings can be selected in Secondary Parameter menu and the default setting is Rs-Rp.

- Rs-Rp: the meter displays series resistance (R_s) or parallel resistance (R_p). If the circuit mode is selected as series, R_s will be displayed. If the circuit mode is selected as parallel, R_p will be displayed.
- D-Q: the meter displays dissipation factor (D) or quality factor (Q). If a capacitor is being measured, D will be displayed. If an inductor is being measured, Q will be displayed.
- Exit: Return to the measurement display.



Figure 2-19: Secondary Parameter Menu

Sorting Menu

Sorting menu is used to set the component type in sorting mode. The following settings can be selected:

- Sort R: the meter measures the resistance of the component under test and tells the user whether it is in the range or not.
- Sort L: the meter measures the inductance of the component under test and tells the user whether it is in the range or not.
- Sort C: the meter measures the capacitance of the component under test and tells the user whether it is in the range or not.
- Exit: Return to the measurement display.



Figure 2-20: Sorting Menu

Recording Menu

Recording menu is used to set the component type in recording mode. The following settings can be selected:

- REC. R: recording resistance.
- REC. L: recording inductance.
- REC. C: recording capacitance.
- Exit: Return to the measurement display.

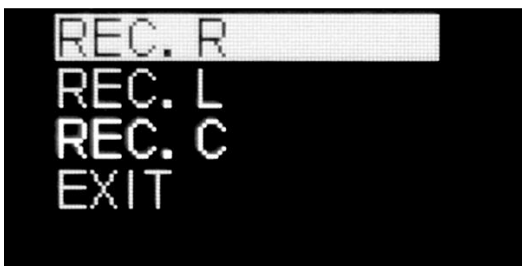

Figure 2-21: Recording Menu

Test Parameters Menu

8 items can be selected in parameters menu as described in Table 2-5.

Table 2-5 Description of Test Parameter Menu

| Menu Item | Description | Learn More On: |
|--------------|--|----------------------------------|
| PAR. Autoset | Reset all the settings to default in the test parameters menu. | Page 18 |
| Test FREQU. | Set the frequency of the test signal. | Page 18, Page 29 |
| Test VOLT. | Set the voltage level of the test signal. | Page 19, Page 29 |
| CIRC. Mode | Set the circuit mode. | Page 19, Page 29 |
| Phase Angle | Set the phase angle condition for automatic component identification mode. | Page 20 |
| Set CONTIN. | Set the threshold in continuity mode. | Page 20 |
| SORT. TOLER. | Set the tolerance range in sorting mode. | Page 21 |
| SORT. REF. | Set or view the reference values used in sorting mode. | Page 21 |
| Exit | Return to the measurement display | |



Figure 2-22: Test Parameters Menu

Parameter Autoset

Parameter Autoset is used to reset the following test parameters to default:

- Test Frequency: Auto
- Voltage Level: 1.0Vrms
- Circuit Mode: Auto
- Phase Angle: 10°

Test Frequency Menu

Test Frequency menu is used to set the frequency of the test signal. The default setting is Auto and the following settings can be selected:

- Auto: auto frequency (AF) mode, the meter automatically selects the best test frequency.
- 100Hz: set test frequency to 100Hz.
- 120Hz: set test frequency to 120Hz.
- 1kHz: set test frequency to 1kHz.
- 10kHz: set test frequency to 10kHz.
- 100kHz: set test frequency to 100kHz.

- Exit: Return to the measurement display.



Figure 2-23: Test Frequency Menu

Test Voltage Menu

Test Voltage menu is used to set the voltage level of the test signal. The default setting is 1.0Vrms and the following settings can be selected:

- 1.0Vrms: set test voltage to 1.0Vrms.
- 0.5Vrms: set test voltage to 0.5Vrms.
- 0.2Vrms: set test voltage to 0.2Vrms.
- Exit: Return to the measurement display.



Figure 2-24: Test Voltage Menu

Circuit Mode Menu

Circuit Mode menu is used to set the secondary parameters on the display. The default setting is Auto and the following settings can be selected:

- Auto: set to auto circuit mode. Series or parallel circuit mode will be automatically identified.
- Series: set to series circuit mode.
- Parallel: set to parallel circuit mode.
- Exit: Return to the measurement display.



Figure 2-25: Secondary Parameters Menu

Phase Angle Menu

Phase angle menu is used to set the phase angle condition for auto component identification. When the meter works in auto mode, it automatically identifies component type according to the phase angle setting. The default setting is 10° and the following settings can be selected:

- 5°
- 10°
- 15°
- 20°
- 30°
- 45°
- Exit: Return to the measurement display.



Figure 2-26: Phase Angle Menu

Set Continuity Menu

Set Continuity menu is used to set the resistance threshold. When the meter works in continuity mode, it beeps if the component has a resistance less than the threshold. The default setting is 10Ω and the following settings can be selected:

- 0.1Ω
- 1Ω
- 10Ω
- 100Ω
- 1kΩ
- Exit: Return to the measurement display.



Figure 2-27: Continuity Threshold Menu

Sorting Tolerance Menu

Sorting Tolerance menu is used to set the sorting tolerance ranges. When the meter works in sorting mode, it beeps once if the component under test is within the tolerance range. If the component under test is out of the tolerance range, the meter beeps three times. The default setting is 10% and the following settings can be selected:

- 0.5%
- 1.0%
- 5.0%
- 10.0%
- 20.0%
- 30.0%
- Exit: Return to the measurement display.

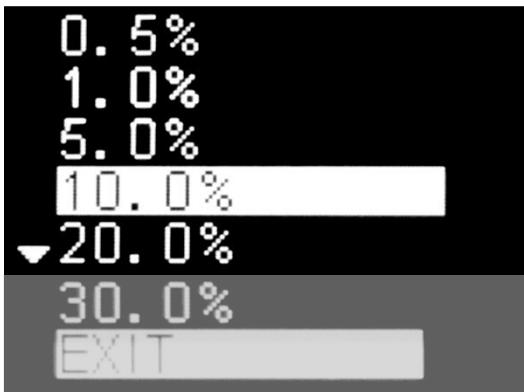

Figure 2-28: Sorting Tolerance Menu

Sorting Reference Menu

Sorting Reference menu is used to view or set the reference values used in sorting mode. The following settings can be selected:

- View REF. VA: view the existing reference values.
- Input REF. R: type in the new reference value for resistance.
- Input REF. L: type in the new reference value for inductance.
- Input REF. C: type in the new reference value for capacitance.
- Exit: Return to the measurement display.



Figure 2-29: Sorting Reference Menu

Viewing Sorting Reference Values

The meter can store 3 reference values for sorting mode: one for resistance, one for inductance and one for capacitance. The default setting is 1K Ω for resistance, 1 μ F for capacitance and 1mH for inductance as Figure 2-30 shows.



Figure 2-30: View Reference Values

Table 2-6 describes how to select the option from main menu to view sorting reference values.

Table 2-6: View Sorting Reference Values

| Settings | Available Options | Menu Structure |
|-------------------------------|-------------------------------|---|
| View Sorting Reference Values | View Sorting Reference Values | Main Menu -> Test PARAM. -> SORT. REF -> View REF. VA |

Typing in a New Sorting Reference Value

User can type in a value and save it as the sorting reference value. When a new value is saved, it overwrites the old value.

Table 2-7 describes how to select settings from main menu to set up new reference values.

Table 2-7: Parameter Settings to Set Up New Reference Values

| Settings | Available Options | Menu Structure |
|-------------------------------------|---|--|
| Set Up New Sorting Reference Values | Input REF. R, Input REF. L, Input REF. C, | Main Menu -> Test PARAM. -> SORT. REF. |

Below is an example to explain how to input a new reference resistance value. The same rule applies to input new inductance or capacitance reference value as well.

To input a new reference resistance value, please select the "Input REF. R" option as Table 2-7 indicates. Once it is selected, the meter asks user to input 5 digits reference value including the decimal. Please follow the on screen instruction to use the "Up" and "Down" buttons to select the desired number, then press the "Select" button to move to the next digit. Figure 2-31 shows a display that 5 digits (80.860) have been input.



Figure 2-31: Input Digits of Reference Resistance Value

After 5 digits are typed in, the meter asks user to select unit. Press the "Up" or "Down" button to switch 4 options including mΩ, Ω, kΩ, MΩ. Then press the "Select" button to select the desired unit. Figure 2-32 shows a display that the unit (kΩ) has been selected.



Figure 2-32: Input Unit for Reference Resistance Value

Once the unit is selected, the meter asks user whether to save the value as the reference value or not. As Figure 2-33 shows, user can discard the value by pressing the "Up" or "Down" button or save the value by pressing the "Select" button.



Figure 2-33: Save Reference Resistance Value from Inputting

If "Select" button is pressed, such value (80.860 kΩ) is saved as the new reference value for resistance sorting as Figure 2-34 shows.



Figure 2-34: View Reference Values

NOTE

- (1) The sorting reference value can be set up by either inputting a value or measuring a component and saving the actual result as the reference value. To get detailed instruction on how to set up the reference value by measuring, please refer to page 34: [Holding the Display](#).
- (2) After the battery is completely dead or hardware reset is performed, all the sorting reference values will be reset to default. Please set these values again if necessary.

Making Measurements

The meter provides 7 measurement types which are: LCRZ, ESR, DCR, diode, continuity, sorting and recording. This chapter describes how to select a measurement type, set parameters, perform measurements and get the results of the component under test.

WARNING

To avoid electrical hazards and possible damage to the meter or to the equipment under test, always discharge the capacitor to be tested before measuring. For in circuit measurement, always disconnect circuit power and discharge all high-voltage capacitors before testing.

NOTE

When doing in circuit testing, the test result may be affected by other components that connect to the component under test. The component under test may need to be isolated from other components in order to get accurate result.

LCRZ Measurement

LCRZ measurement includes auto mode (Auto), resistance measurement (R), inductance measurement (L), capacitance measurement (C) and impedance measurement (Z).

Figure 3-1 shows a typical display in LCRZ measurement. It shows test frequency and test voltage on the top. The primary display is in the middle showing component type and measurement result. The secondary parameter reading is shown underneath the primary display. The circuit mode, sound icon and battery indicator are displayed on the bottom.

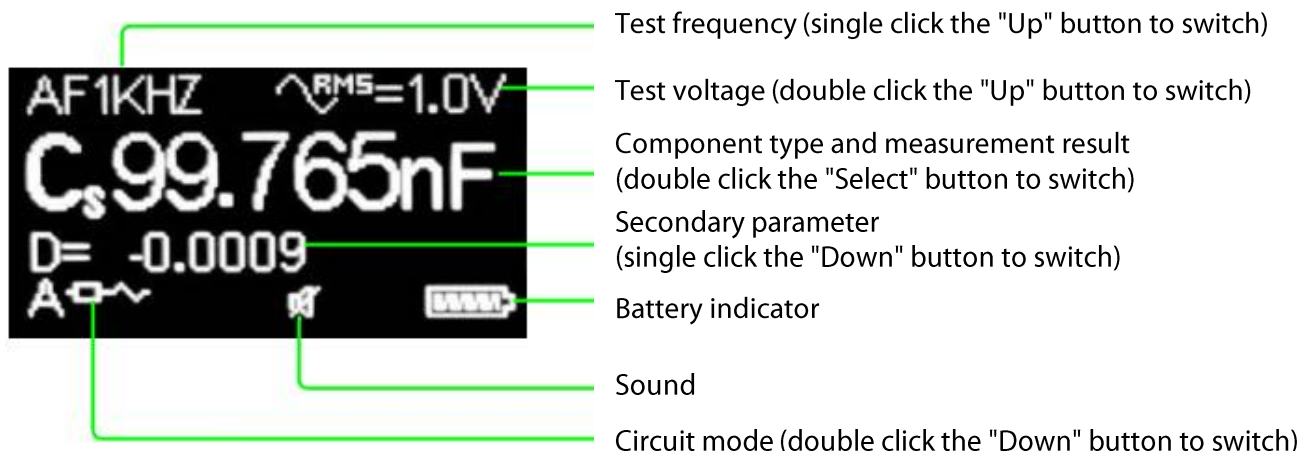

Figure 3-1: Display of LCRZ Measurement

Shortcuts are provided to quickly select the settings. Below are the available shortcuts in LCRZ measurement:

- Single click the "Up" button to switch test frequency as Figure 3-2 shows.
- Double click the "Up" button to switch test voltage as Figure 3-3 shows.
- Double click the "Select" button to switch component type as Figure 3-4 shows.
- Single click the "Down" button to switch secondary parameter setting as Figure 3-5 shows.
- Double click the "Down" button to switch circuit mode as Figure 3-6 shows.
- Press down the "Select" button for half second or so to go to the main menu screen.

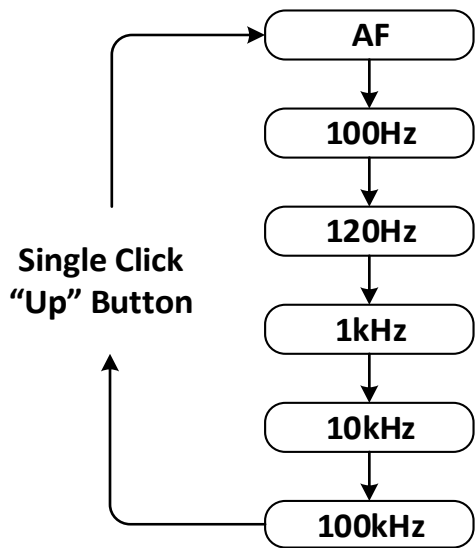

Figure 3-2: Switch Test Frequency by Single Clicking the "Up" Button

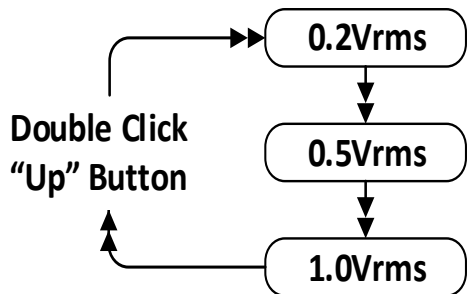

Figure 3-3: Switch Test Voltage by Double Clicking the "Up" Button

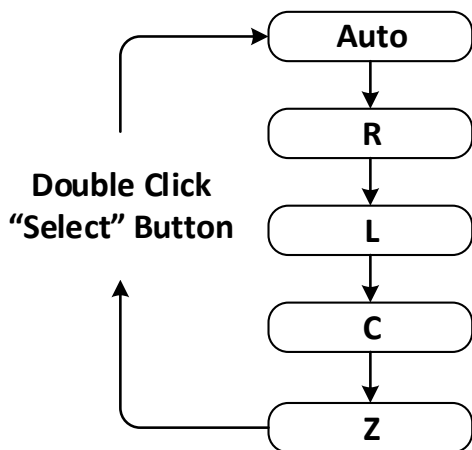

Figure 3-4: Switch Component Type by Double Clicking the "Select" Button

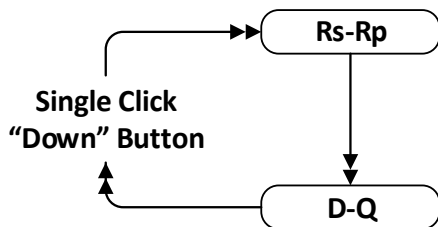

Figure 3-5: Switch Secondary Parameter Setting by Single Clicking the "Down" Button

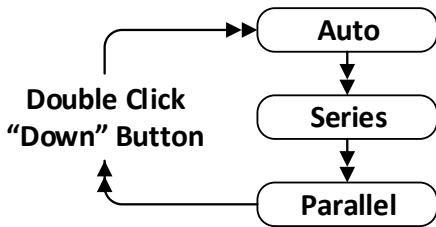

Figure 3-6: Switch Circuit Mode by Double Clicking the "Down" Button

Auto Mode

In auto mode, the meter identifies resistance (R), inductance (L) and capacitance (C) automatically.

Table 3-1 describes how to set up the meter to auto mode.

Table 3-1: Set Up Auto Mode

| Settings | Menu Structure |
|----------|--|
| Auto | Main Menu -> Measurement -> LCRZ -> Auto |

In auto mode, the meter identifies L, C, and R according to the angle of impedance detected in the component under test. Table 3-2 lists the phase angle rules and the phase angle settings are described on page 20: [Phase Angle](#).

Table 3-2 Auto Mode Phase Angle Rules

| Phase Angle Setting | Primary Display |
|------------------------------|-----------------|
| $ Q < \text{phase angle}$ | R |
| $Q \geq +\text{phase angle}$ | L |
| $Q \leq -\text{phase angle}$ | C |

NOTE

- (1) When auto mode is selected, the testing frequency and secondary parameter stay unchanged. To change them separately, please refer page 29: [Selecting Circuit Mode](#) and page 29: [Selecting Test Frequency](#).
- (2) The autoset option in main menu can be used to reset the meter to the default mode (auto mode with auto testing frequency and auto circuit mode). Please refer page 9: [Autoset](#) to know which settings will be reset when autoset is selected.

Measuring Resistance (R)

Table 3-3 describes how to set up the meter to resistance measurement. In R mode, the meter shows phase angle (θ) as the secondary parameter.

Table 3-3: Set Up Resistance Measurement

| Settings | Menu Structure |
|----------|---------------------------------------|
| R | Main Menu -> Measurement -> LCRZ -> R |

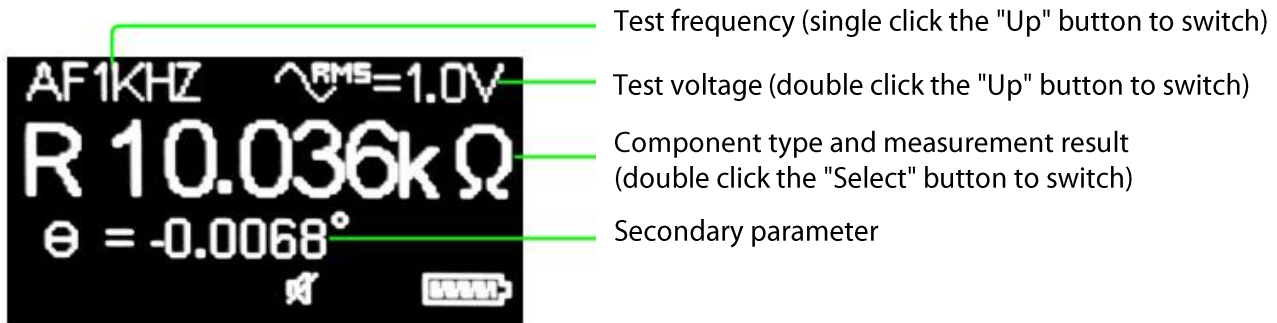

Figure 3-7: Display of R measurement

Measuring Inductance (L)

Table 3-4 describes how to set up the meter to inductance measurement.

Table 3-4: Set Up Inductance Measurement

| Settings | Menu Structure |
|----------|---------------------------------------|
| L | Main Menu -> Measurement -> LCRZ -> L |

In L mode, the component type shows L_s when circuit mode is selected as series and shows L_p when circuit mode is selected as parallel. If auto circuit mode is selected, series circuit mode will always be used for inductance measurement.

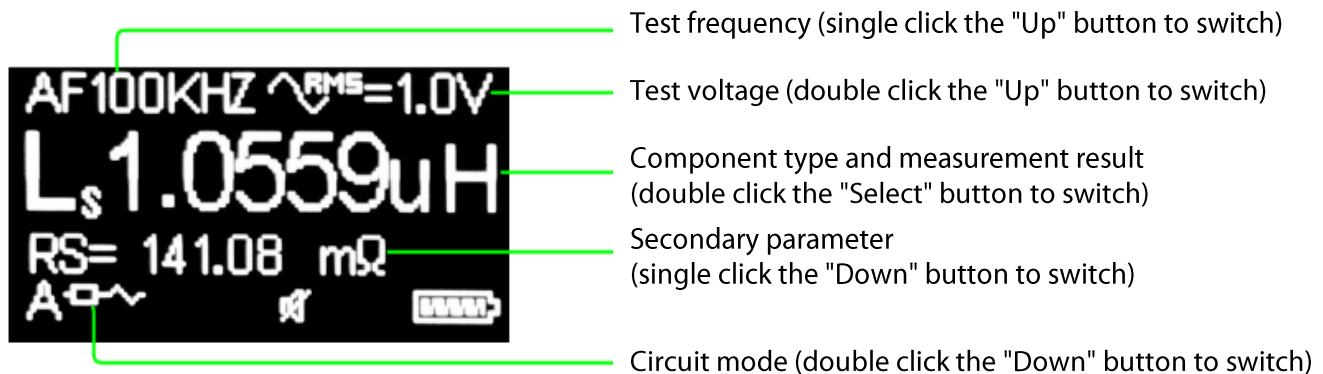

Figure 3-8: Display of L measurement

Measuring Capacitance (C)

Table 3-5 describes how to set up the meter to capacitance measurement.

Table 3-5: Set Up Capacitance Measurement

| Settings | Menu Structure |
|----------|---------------------------------------|
| C | Main Menu -> Measurement -> LCRZ -> C |

In C mode, the component type shows C_s when circuit mode is selected as series and shows C_p when circuit mode is selected as parallel. If auto circuit mode is selected, series circuit mode or parallel circuit mode will be automatically identified. See Table 3-9 for the series/parallel rules used.

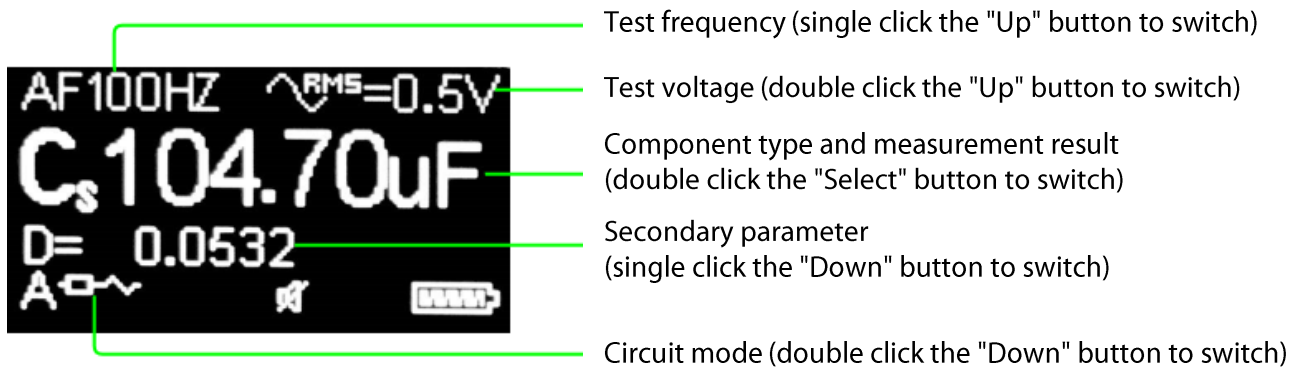

Figure 3-9: Display of C measurement

Measuring Impedance (Z)

The impedance measurement is used to measure the combination of Resistance (R) and Reactance (X) and is measured in ohms (Ω). All circuit components, resistors, capacitors, and inductors have parasitic components, such as unwanted inductance in resistors, unwanted resistance in capacitors, unwanted capacitance in inductors, etc. Thus, simple components should be modeled as complex impedances. In Z mode, the meter shows phase angle (θ) as the secondary parameter.

Table 3-6 describes how to set up the meter to measure impedance.

Table 3-6: Set Up Impedance Measurement

| Settings | Menu Structure |
|----------|---------------------------------------|
| Z | Main Menu -> Measurement -> LCRZ -> Z |

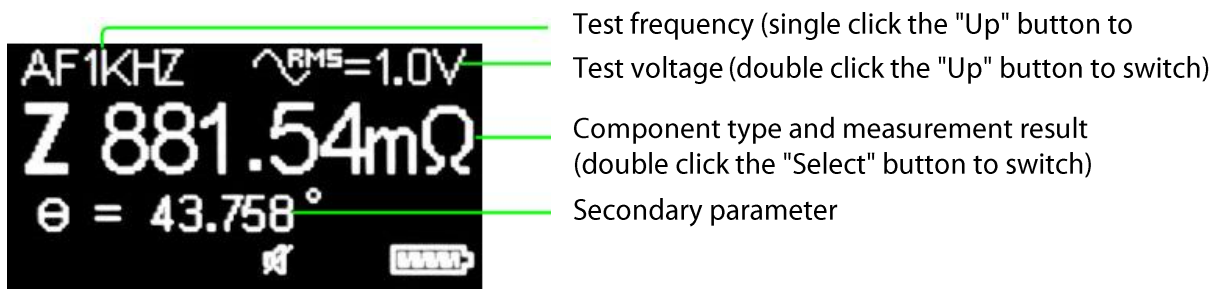

Figure 3-10: Display of Z measurement

Selecting Secondary Parameters

Table 3-7 describes how to set up secondary parameters from the main menu.

Table 3-7: Set Up Secondary Parameter

| Settings | Available Options | Menu Structure | Learn More On: |
|----------------------|-------------------|---|-------------------------|
| Secondary Parameters | Rs-Rp, D-Q | Main Menu -> Measurement -> SEC. PARAM. | Page 16 |

If resistance mode (Rs-Rp) is selected, the meter shows Rs when circuit mode is selected as series and shows Rp when circuit mode is selected as parallel. If dissipation or quality factor mode (D-Q) is selected, the meter shows D when measuring capacitance and shows Q when measuring inductance.

Selecting Circuit Mode

Table 3-8 describes how to set up circuit mode from the main menu.

Table 3-8: Set Up Circuit Mode

| Settings | Available Options | Menu Structure | Learn More On: |
|--------------|------------------------|--|-------------------------|
| Circuit Mode | Auto, Series, Parallel | Main Menu -> Test PARAM. -> CIRC. Mode | Page 19 |

If auto mode is selected, series circuit mode or parallel circuit mode will be automatically identified. See Table 3-9 for the series/parallel rules used.

Table 3-9 Auto Mode Series/Parallel Rules

| Range of Component Under Test | Circuit Mode Selected in Auto Mode |
|-------------------------------|------------------------------------|
| $C < 500 \text{ pF}$ | Parallel Circuit Mode |
| $C \geq 500 \text{ pF}$ | Series Circuit Mode |
| L | Always Series Circuit Mode |

Selecting Test Frequency

Table 3-10 describes how to set up test frequency from the main menu.

Table 3-10: Set Up Test Frequency

| Settings | Available Options | Menu Structure | Learn More On: |
|----------------|---|---|-------------------------|
| Test Frequency | Auto, 100Hz, 120Hz, 1kHz, 10kHz, 100kHz | Main Menu -> Test PARAM. -> Test FREQU. | Page 18 |

NOTE

The meter is able to use auto frequency to measure capacitance approximately from 3 pF to 199 μF and inductance approximately from 1 μH to 100mH. To measure capacitance or inductance out of this range, please select proper testing frequency manually according to [Table 4-3: Measurement Ranges and Optimal Testing Frequency](#).

Selecting Test Voltage

Table 3-11 describes how to set up test voltage from the main menu.

Table 3-11: Set Up Test Voltage

| Settings | Available Options | Menu Structure | Learn More On: |
|--------------|---------------------------|--|-------------------------|
| Test voltage | 0.2Vrms, 0.5Vrms, 1.0Vrms | Main Menu -> Test PARAM. -> Test VOLT. | Page 19 |

NOTE

The voltage specified in the test voltage menu is root mean square (RMS) value. When converted to peak to peak value, 0.2Vrms equals to 0.57Vp-p, 0.5Vrms equals to 1.4Vp-p and 1.0Vrms equals to 2.8Vp-p.

ESR Measurement

The ESR measurement is used to measure the the equivalent series resistance of the capacitor, independent of its capacitance.

Table 3-12 describes how to select ESR settings from main menu.

Table 3-12: Parameter Settings in ESR Measurement

| Settings | Menu Structure |
|-----------------|---------------------------------|
| ESR Measurement | Main Menu -> Measurement -> ESR |

Figure 3-11 shows a typical display in ESR measurement.

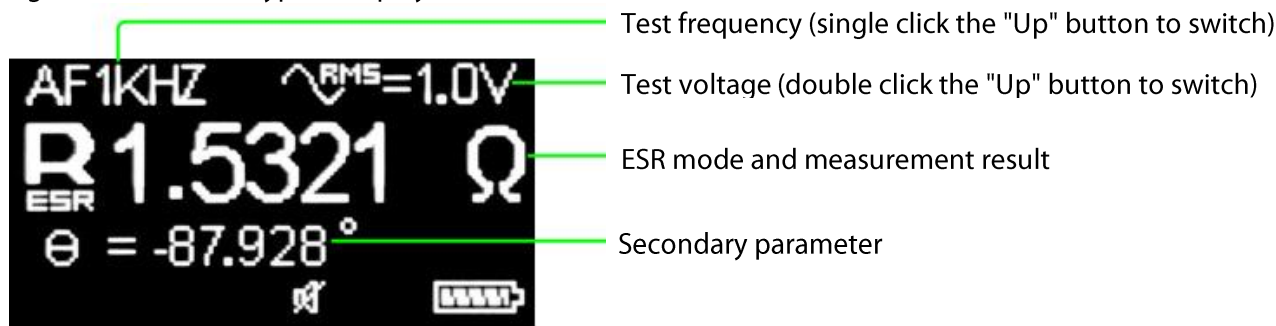

Figure 3-11: Display of ESR Measurement

Shortcuts are provided to quickly select the settings. Below are the available shortcuts in ESR measurement.

- Single click the "Up" button to switch test frequency as [Figure 3-2](#) shows.
- Double click the "Up" button to switch test voltage as [Figure 3-3](#) shows.
- Press down the "Select" button for half second or so to go to the main menu screen.

DCR Measurement

The DCR measurement is used to measure the resistance of an unknown component by applying 1Vdc.

Table 3-13 describes how to select DCR settings from main menu.

Table 3-13: Parameter Settings in DCR Measurement

| Settings | Menu Structure |
|-----------------|---------------------------------|
| DCR Measurement | Main Menu -> Measurement -> DCR |

Figure 3-12 shows a typical display in DCR measurement.



Figure 3-12: Display of DCR Measurement

During DCR measurement, user can press down the "Select" button for half second or so to go to the main menu screen.

Diode Measurement

The diode measurement is used to test a diode. Connect the meter tips across the component under test. If the meter detects it is a good diode, it shows diode polarity and its forward voltage vs the current flowing through the diode. If a faulty condition is detected, the meter shows one of the following messages:

- Open: High impedance is detected, i.e. an open circuit failure diode.
- Short: Short circuit is detected, i.e. a short circuit failure diode.
- Damage: Neither high impedance nor short circuit is detected, but the component under test doesn't show proper diode functions. It could be a partially damaged diode.

Table 3-14 describes how to select diode settings from main menu.

Table 3-14: Parameter Settings in Diode Measurement

| Settings | Menu Structure |
|-------------------|-----------------------------------|
| Diode Measurement | Main Menu -> Measurement -> Diode |

Figures 3-13 shows a typical display when a good diode is detected. Figures 3-14 shows a typical display when a damaged diode is detected.



Figure 3-13: Display of Diode Measurement (Good Diode)



Figure 3-14: Display of Diode Measurement (Damaged Diode)

During diode measurement, user can press down the "Select" button for half second or so to go to the main menu screen.

The LCR Pro1 Plus device is able to test LEDs. It lights up the LED and displays its electrical parameters, such as polarity, forward voltage and forward current. When testing bi-directional LEDs, the electrical parameters will be displayed in each direction. Figures 3-15 shows a typical display during LED testing.

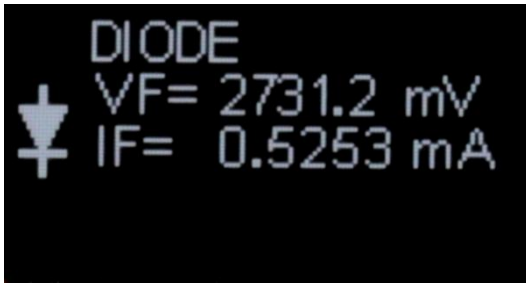

Figure 3-15: Display of LED Measurement

Figure 3-16 shows a typical display when testing an LED with built-in ESD protection diode (reverse polarity). VF/IF indicate LED voltage and current (in forward direction). VR/IR indicate ESD protection diode voltage and current (in reverse direction).

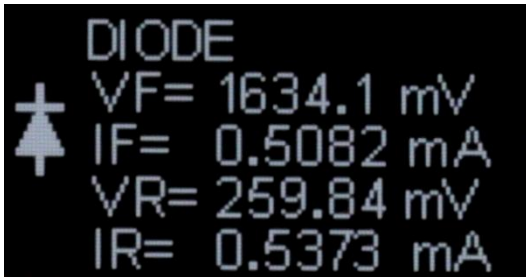

Figure 3-16: Display of LED Measurement (bi-directional LED)

Continuity Measurement

Continuity is the presence of a complete electrical path for current flow. The continuity measurement can be used to test fuses, connectors, switches and other components. Connect the meter tips across the component under test. If the meter detects the component resistance less than the threshold, it beeps. Otherwise, it will not beep.

Table 3-15 describes how to select continuity settings from main menu.

Table 3-15: Parameter Settings in Continuity Measurement

| Settings | Available Options | Menu Structure | Learn More On: |
|----------------------|------------------------------------|---|-------------------------|
| Continuity | Continuity | Main Menu -> Measurement -> Continuity | |
| Continuity Threshold | 0.1Ω, 0.5 Ω, 1 Ω, 10 Ω, 100 Ω, 1KΩ | Main Menu -> Test PARAM. -> Set CONTIN. | Page 20 |

Figure 3-17 shows a typical display in continuity measurement. It shows test frequency and test voltage on the top. The primary display is in the middle showing the resistance result. The continuity threshold is shown on the bottom. The continuity threshold can be increased by single clicking the "Up" button and can be decreased by single clicking the "Down" button.

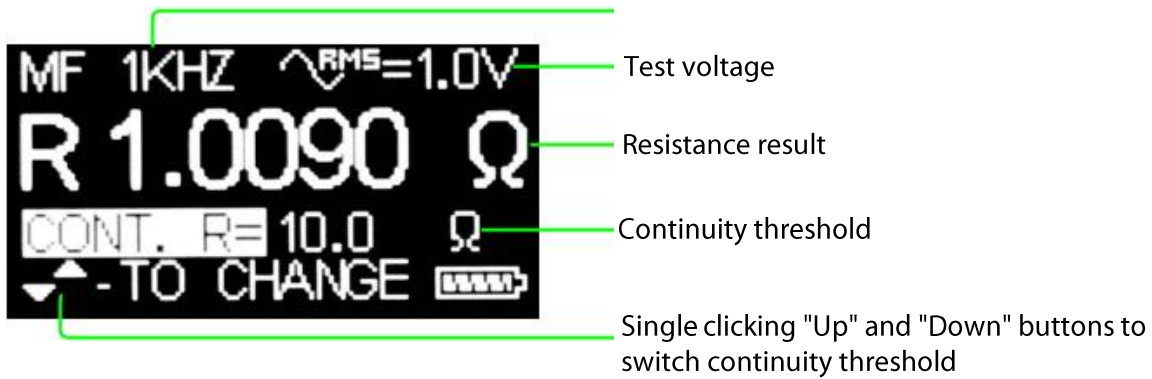

Figure 3-17: Display of Continuity Measurement

During continuity measurement, user can press down the "Select" button for half second or so to go to the main menu screen.

NOTE

In continuity mode, the meter always uses test frequency 1KHz and test voltage 1.0Vrms for the resistance measurement.

Sorting Mode

The Sorting mode is used to sort out components according to the preset component type, reference value and tolerance range. In sorting mode, the meter measures the component under test and calculates the error percentage using the measured result and the reference value. Then it compares the error percentage with the tolerance range. It beeps three times if the result is out of range. If the result is within the range, the meter beeps once.

Table 3-16 describes how to select sorting settings from main menu.

Table 3-16: Parameter Settings in Sorting Mode

| Settings | Available Options | Menu Structure | Learn More On: |
|-------------------|--|--|-------------------------|
| Sorting | Sort R, Sort L, Sort C | Main Menu -> Measurement -> Sorting | Page 17 |
| Sorting Tolerance | 0.5%, 1%, 5%, 10%, 20% and 30% | Main Menu -> Test PARAM. -> SORT. TOLER. | Page 21 |
| Sorting Reference | View REF. VA Input REF. R Input REF. L Input REF. C | Main Menu -> Test PARAM. -> SORT. REF. | Page 21 |

Figure 3-18 shows a typical display in sorting mode. It shows test frequency and test voltage on the top. The primary display in the middle shows sorting type (R, L or C) and measurement result. The reference value and tolerance range shows underneath the primary display. The error percentage is shown on the bottom.

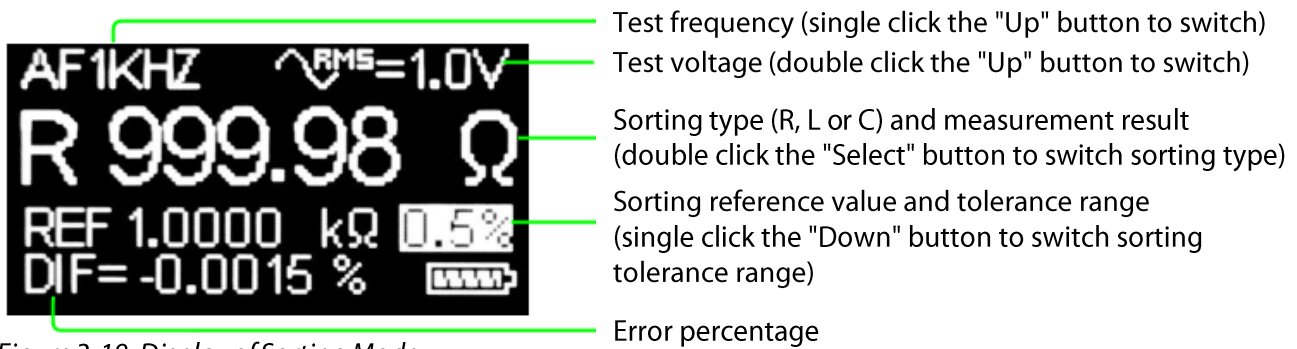

Figure 3-18: Display of Sorting Mode

Shortcuts are provided to quickly select the settings. Below are the available shortcuts in sorting mode.

- Single click the "Up" button to switch test frequency as Figure 3-2 shows.
- Double click the "Up" button to switch test voltage as Figure 3-3 shows.
- Double click the "Select" button to switch sorting type as Figure 3-19 shows.
- Single click the "Down" button to switch sorting tolerance range as Figure 3-20 shows.
- Press down the "Select" button for half second or so to go to the main menu screen.

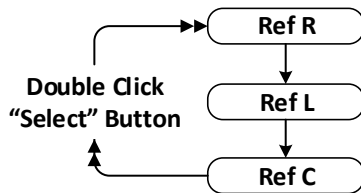

Figure 3-19: Switch Sorting Type by Double Clicking the "Select" Button

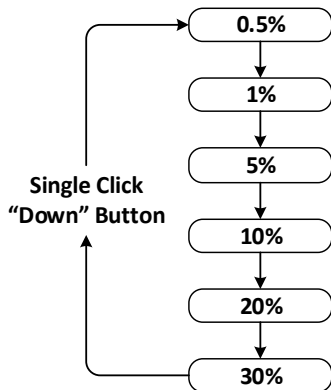

Figure 3-20: Switch Sorting Tolerance Range by Single Clicking the "Down" Button

NOTE

- (1) Some components under test may be sensitive to certain test parameters, such as test frequency, test voltage, etc. In order to get the desired measurement result, please set the proper test parameters before measuring such components.
- (2) After the battery is completely dead or hardware reset is performed, all the sorting reference values will be removed. Please set these values again if necessary.

Recording Mode

The Recording mode is used to record the maximum, minimum and average results during a series of measurements. In recording mode, the meter averages all the results taken since the recording mode was activated. When the new measurement result goes below the recorded minimum value or above the recorded maximum value, the meter beeps and overwrites the old value with the new value.

Table 3-17 describes how to select recording settings from main menu.

Table 3-17: Parameter Settings in Recording Mode

| Settings | Available options | Menu structure | Learn More On: |
|----------------|------------------------|--|-------------------------|
| Recording Type | REC. R, REC. L, REC. C | Main Menu -> Measurement -> Recording | Page 17 |

Figure 3-21 shows a typical display in recording mode. It shows test frequency and test voltage on the top. The primary display in the middle shows recording type (R, L or C) and measurement result. The maximum and minimum values are alternatively displayed underneath the primary display in every 2 seconds or so. The average value and measurement cycle are alternatively displayed on the bottom in every 2 seconds or so.

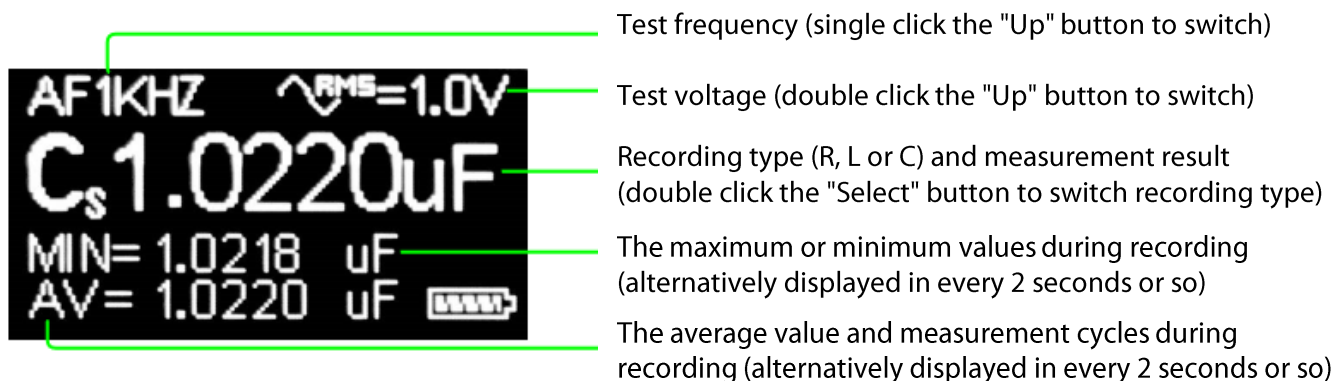

Figure 3-21: Display of Recording Mode

During recording measurement, user can press down the "Select" button for half second or so to go to the main menu screen.

NOTE

In recording mode, the meter captures only stable values and updates the memory. It will not record any overload value and will only record resistance from 0.2Ω to 10MΩ, inductance from 0.2uH to 1H and capacitance from 3pF to 1mF. Therefore, before beginning recording, please set the proper test parameters, such as component type, test frequency, etc.

Holding the Display

When the meter is measuring a component, the latest result can be held on the display by single clicking the "Select" button. When the hold function is active, the "Hold" annunciator is shown on the display as Figure 3-22 shows.

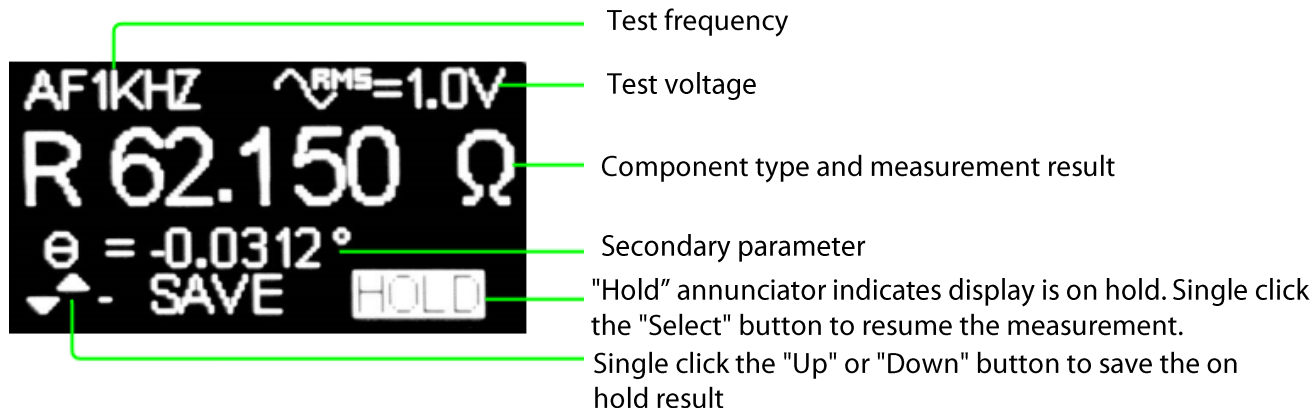

Figure 3-22: Holding the Display

When the display is on hold, user can single click the "Select" button to resume the measurement or press down the "Select" button for half second or so to go to the main menu screen. When a resistance, inductance or capacitance result is on hold, the display shows the up and down arrows with the SAVE message on the bottom left of the screen as Figure 3-22 shows. When single clicking the "Up" or "Down" button, a Value Saved screen pops up as Figure 3-23 shows. It indicates the on hold result is successfully saved as the new sorting reference value.



Figure 3-23: Value Saved Display

Characteristics and Specifications

Product Characteristics

Table 4-1 Product Characteristics

| | |
|---------------------------|---|
| Dimensions (L x W x H) | 151 x 19 x 15mm |
| Weight | 30 grams |
| Display | 0.96-inch, 128x64 OLED display |
| Battery | 150 mAH internal lithium-ion polymer battery |
| Battery Life | 1 day in typical measurement ⁽¹⁾ |
| Charging Source | USB port USB power adapter (output voltage DC 5V ± 5%) |
| Charging Time | 2.5 hours (typical) |
| Measurement Speed | 0.5sec, 1sec (typical) or 2 seconds |
| Operating Environment | Operating temperature from -10°C to 50°C, 0% to 80% RH Full accuracy up to 80% RH for temperature 23°C ± 3°C |
| Storage Compliance | -20°C to 60°C, 0% to 80% RH |
| Safety and EMC Compliance | IEC61000-4-2 - ESD (4 kV Contact, 8 kV Air) EN 61000-4-3 - Radiated Immunity IEC61000-4-8 - Magnetic Field Immunity FCC15/EN 55011/ICES-003 - Class B, Radiated Emissions FCC15 Class B Conducted Emissions |
| Calibration Cycle | 1 Year (Recommended) |

NOTE

Battery life varies by use, configuration, and many other factors. Actual results may vary.

Electrical Specifications

Testing Signal Specifications

Table 4-2 Testing Signal Specifications

| | |
|----------------------------|---|
| Testing Frequency | 100Hz, 120Hz, 1kHz, 10kHz, 100kHz |
| Testing Frequency Accuracy | 50 ppm (0.005%) |
| Testing Signal Level | 0.2Vrms/0.5Vrms/1.0Vrms, +/- 5% sine wave |
| Source Impedance | 100Ω ± 1% |

Measurement Ranges and Optimal Testing Frequency

Table 4-3 Measurement Ranges and Optimal Testing Frequency

| Parameter | Measurement range | Optimal testing frequency |
|-------------|-------------------|---------------------------|
| Resistance | 25mΩ to 10MΩ | 1kHz |
| Capacitance | 0.2pF to 40nF | 10kHz |
| | 40nF to 40uF | 1kHz |
| | 40uF to 1mF | 100Hz |
| Inductance | 10nH to 1uH | 100kHz |
| | 1uH to 1mH | 10kHz |
| | 1mH to 100mH | 1kHz |
| | 100mH to 1H | 100Hz |

Resistance Accuracy Specifications

Table 4-4 LCR Pro1/Pro1 Plus Resistance Accuracy Specification (at 1.0Vrms test voltage)

| Range | Resolution | Accuracy = A_z + Offset | | | | |
|----------------|------------------|---------------------------|------------------------|------------------------|------------------------|------------------------|
| | | 100Hz | 120Hz | 1kHz | 10kHz | 100kHz |
| 1000m Ω | 0.01m Ω | 0.5% + 20m Ω | 0.5% + 20m Ω | 0.5% + 20m Ω | 0.5% + 20m Ω | 1.0% + 20m Ω |
| 10 Ω | 0.0001 Ω | 0.3% + 0.02 Ω | 0.3% + 0.02 Ω | 0.3% + 0.02 Ω | 0.3% + 0.02 Ω | 0.7% + 0.02 Ω |
| 100 Ω | 0.001 Ω | 0.2% + 0.03 Ω | 0.2% + 0.03 Ω | 0.2% + 0.03 Ω | 0.2% + 0.03 Ω | 0.5% + 0.03 Ω |
| 1000 Ω | 0.01 Ω | 0.2% + 0.3 Ω | 0.2% + 0.3 Ω | 0.2% + 0.3 Ω | 0.2% + 0.3 Ω | 0.3% + 0.3 Ω |
| 10k Ω | 0.0001k Ω | 0.2% + 0.003k Ω | 0.2% + 0.003k Ω | 0.1% + 0.003k Ω | 0.2% + 0.003k Ω | 0.5% + 0.003k Ω |
| 100k Ω | 0.001k Ω | 0.1% + 0.05k Ω | 0.1% + 0.05k Ω | 0.1% + 0.05k Ω | 0.1% + 0.05k Ω | --- |
| 1000k Ω | 0.01k Ω | 0.3% + 0.5k Ω | 0.3% + 0.5k Ω | 0.3% + 0.5k Ω | 0.3% + 0.5k Ω | --- |
| 10M Ω | 0.0001M Ω | 2.0% + 0.008M Ω | 2.0% + 0.008M Ω | 2.0% + 0.008M Ω | --- | --- |

NOTE

The measurements are performed with necessary open and short calibration done prior to verifying the meter's accuracy.

Table 4-5 LCR Pro1/Pro1 Plus Resistance Accuracy Specification (at 0.2Vrms and 0.5Vrms test voltage)

| Range | Resolution | Accuracy = A_z + Offset | |
|----------------|------------------|---------------------------|------------------------|
| | | 0.2Vrms | 0.5Vrms |
| 1000m Ω | 0.01m Ω | 1.0% + 20m Ω | 1.0% + 20m Ω |
| 10 Ω | 0.0001 Ω | 1.0% + 0.02 Ω | 1.0% + 0.02 Ω |
| 100 Ω | 0.001 Ω | 1.0% + 0.03 Ω | 1.0% + 0.03 Ω |
| 1000 Ω | 0.01 Ω | 1.0% + 0.3 Ω | 1.0% + 0.3 Ω |
| 10k Ω | 0.0001k Ω | 0.7% + 0.003k Ω | 0.5% + 0.003k Ω |
| 100k Ω | 0.001k Ω | 0.7% + 0.05k Ω | 0.5% + 0.05k Ω |
| 1000k Ω | 0.01k Ω | 1.0% + 0.5k Ω | 1.0% + 0.5k Ω |
| 10M Ω | 0.0001M Ω | 5.0% + 0.008M Ω | 5.0% + 0.008M Ω |

NOTE

(1) The measurements are performed with necessary open and short calibration done prior to verifying the meter's accuracy.

(2) Accuracy is specified at optimum test frequency as Table 4-3 indicates.

Inductance Accuracy Specifications

Table 4-6 LCR Pro1 Inductance Accuracy Specifications (at 1.0Vrms test voltage)

| Range | Resolution | Accuracy = A_L + Offset | | | | |
|--------|------------|---------------------------|---------------|----------------|----------------|---------------|
| | | 100Hz | 120Hz | 1kHz | 10kHz | 100kHz |
| 1000nH | 0.01nH | --- | --- | --- | --- | 2.5% + 10nH |
| 10uH | 0.0001uH | --- | --- | --- | 1.0% + 0.01uH | 2.5% + 0.02uH |
| 100uH | 0.001uH | --- | --- | --- | 0.7% + 0.03uH | 2.0% + 0.2uH |
| 1000uH | 0.01uH | --- | --- | 0.5% + 0.3uH | 0.5% + 0.3uH | 0.8% + 2.0uH |
| 10mH | 0.0001mH | --- | --- | 0.2% + 0.003mH | 0.5% + 0.003mH | --- |
| 100mH | 0.001mH | 0.5% + 0.03mH | 0.5% + 0.03mH | 0.2% + 0.03mH | 0.5% + 0.03mH | --- |
| 1000mH | 0.01mH | 0.2% + 0.3mH | 0.2% + 0.3mH | 0.5% + 0.3mH | --- | --- |

Table 4-7 LCR Pro1 Plus Inductance Accuracy Specifications (at 1.0Vrms test voltage)

| Range | Resolution | Accuracy = A_L + Offset | | | | |
|--------|------------|---------------------------|---------------|----------------|----------------|---------------|
| | | 100Hz | 120Hz | 1kHz | 10kHz | 100kHz |
| 1000nH | 0.01nH | --- | --- | --- | --- | 2.5% + 5nH |
| 10uH | 0.0001uH | --- | --- | --- | 1.0% + 0.01uH | 2.0% + 0.01uH |
| 100uH | 0.001uH | --- | --- | --- | 0.7% + 0.03uH | 2.0% + 0.2uH |
| 1000uH | 0.01uH | --- | --- | 0.5% + 0.3uH | 0.5% + 0.3uH | 0.8% + 2.0uH |
| 10mH | 0.0001mH | --- | --- | 0.2% + 0.003mH | 0.5% + 0.003mH | --- |
| 100mH | 0.001mH | 0.5% + 0.03mH | 0.5% + 0.03mH | 0.2% + 0.03mH | 0.5% + 0.03mH | --- |
| 1000mH | 0.01mH | 0.2% + 0.3mH | 0.2% + 0.3mH | 0.5% + 0.3mH | --- | --- |

NOTE

(1) The measurements are performed with necessary open and short calibration done prior to verifying the meter's accuracy.

(2) Specification is for LCR Pro1 HW version 1.01 or newer and LCR Pro1 Plus HW version 1.12 or newer

Table 4-8 LCR Pro1/Pro1 Plus Inductance Accuracy Specifications (at 0.2Vrms and 0.5Vrms test voltage)

| Range | Resolution | Accuracy = $A_L + \text{Offset}$ | |
|--------|------------|----------------------------------|----------------|
| | | 0.2Vrms | 0.5Vrms |
| 1000nH | 0.01nH | 1.0% + 40nH | 1.0% + 40nH |
| 10uH | 0.0001uH | 1.0% + 0.04uH | 1.0% + 0.04uH |
| 100uH | 0.001uH | 1.0% + 0.05uH | 1.0% + 0.05uH |
| 1000uH | 0.01uH | 1.0% + 0.3uH | 1.0% + 0.3uH |
| 10mH | 0.0001mH | 1.0% + 0.003mH | 1.0% + 0.003mH |
| 100mH | 0.001mH | 1.0% + 0.03mH | 1.0% + 0.03mH |
| 1000mH | 0.01mH | 1.0% + 0.3mH | 1.0% + 0.3mH |

NOTE

- (1) The measurements are performed with necessary open and short calibration done prior to verifying the meter's accuracy.
- (2) Accuracy is specified at optimum test frequency as Table 4-3 indicates.

Capacitance Accuracy Specifications

Table 4-9 LCR Pro1/Pro1 Plus Capacitance Accuracy Specifications (at 1.0Vrms test voltage)

| Range | Resolution | Accuracy = $A_C + \text{Offset}$ | | | | |
|--------|------------|----------------------------------|----------------|----------------|----------------|---------------|
| | | 100Hz | 120Hz | 1kHz | 10kHz | 100kHz |
| 10pF | 0.0001pF | --- | --- | --- | 1.0% + 0.05pF | 2.5% + 0.2pF |
| 100pF | 0.001pF | --- | --- | --- | 0.8% + 0.2pF | 2.0% + 0.2pF |
| 1000pF | 0.01pF | --- | --- | 0.5% + 0.5pF | 0.5% + 0.3pF | 2.0% + 1.0pF |
| 10nF | 0.0001nF | --- | --- | 0.5% + 0.003nF | 0.5% + 0.003nF | 0.7% + 0.01nF |
| 100nF | 0.001nF | --- | --- | 0.2% + 0.03nF | 0.2% + 0.03nF | 1.0% + 0.1nF |
| 1000nF | 0.01nF | --- | --- | 0.2% + 0.3nF | 0.2% + 0.3nF | --- |
| 10uF | 0.0001uF | 0.3% + 0.003uF | 0.3% + 0.003uF | 0.2% + 0.003uF | --- | --- |
| 100uF | 0.001uF | 0.3% + 0.03uF | 0.3% + 0.03uF | 0.5% + 0.03uF | --- | --- |
| 1000uF | 0.01uF | 0.5% + 0.5uF | 0.5% + 0.5uF | --- | --- | --- |
| 10mF | 0.0001mF | 0.8% + 0.005mF | 0.8% + 0.005mF | --- | --- | --- |

NOTE

- (1) The measurements are performed with necessary open and short calibration done prior to verifying the meter's accuracy.
- (2) The accuracy for the ceramic capacitor will be influenced depending on the dielectric constant (K) of the material used to make the ceramic capacitor.

Table 4-10 LCR Pro1/Pro1 Plus Capacitance Accuracy Specifications (at 0.2Vrms and 0.5Vrms test voltage)

| Range | Resolution | Accuracy = A_c + Offset | |
|--------|------------|---------------------------|-----------------|
| | | 0.2Vrms | 0.5Vrms |
| 10pF | 0.0001pF | 1.0% + 0.2pF | 1.0% + 0.2pF |
| 100pF | 0.001pF | 1.0% + 0.2pF | 1.0% + 0.2pF |
| 1000pF | 0.01pF | 1.0% + 0.3pF | 1.0% + 0.3pF |
| 10nF | 0.0001nF | 1.0% + 0.003nF | 1.0% + 0.003nF |
| 100nF | 0.001nF | 1.0% + 0.03nF | 1.0% + 0.03nF |
| 1000nF | 0.01nF | 1.0% + 0.3nF | 1.0% + 0.3nF |
| 10uF | 0.0001uF | 1.0% + 0.003uF | 1.0% + 0.003uF |
| 100uF | 0.001uF | 1.0% + 0.03uF | 1.0% + 0.03uF |
| 1000uF | 0.01uF | 1.0% + 0.05uF | 1.0% + 0.05uF |
| 10mF | 0.0001mF | 2.0% + 0.0005mF | 2.0% + 0.0005mF |

NOTE

- (1) The measurements are performed with necessary open and short calibration done prior to verifying the meter's accuracy.
- (2) The accuracy for the ceramic capacitor will be influenced depending on the dielectric constant (K) of the material used to make the ceramic capacitor.
- (3) Accuracy is specified at optimum test frequency as Table 4-3 indicates.

LED Testing Accuracy Specifications

Table 4-11 LCR Pro1 Plus LED Testing Accuracy Specifications

| | Range |
|------------------|---------------|
| Max Test Voltage | 2.95V +/- 5% |
| Max Test Current | 0.5mA +/- 10% |
| Voltage Accuracy | 4% + 20mV |
| Current Accuracy | 3% + 20uA |