

Testing Power Semiconductor Devices with Keithley High Power System SourceMeter® SMU Instruments

Introduction

The proliferation of electronic control and electronic power conversion into a variety of industries (e.g., energy generation, industrial motor drives and control, transportation, and IT) has spurred growth in power semiconductor device design and test. To demonstrate technology improvements, new device capabilities must be compared with those of existing devices. The use of semiconductor materials other than silicon demands the use of new processes. And, to be sustainable, these new processes must be tuned to deliver consistent results and high production yield. As new device designs are developed, reliability measurements are performed on many devices over long periods. Therefore, test engineers must identify test equipment that is not only accurate but scalable and cost-effective.

Power module design engineers—the consumers of the discrete power semiconductor components—work at the other end of the semiconductor device testing spectrum. They integrate the discrete components into designs for DC-DC converters, inverters, LED controllers, battery management chips, and many other devices. Driven by demands for higher energy efficiency, these engineers need to qualify the devices they receive from their vendors to ensure that they can withstand use in the application, predict how the efficiency of the power modules may be affected by the device, and finally validate the performance of the end product.

Keithley's SourceMeter SMU instruments give both device test engineers and power module design engineers the tools they need to make the measurements they require. Whether they're familiar with curve tracers, semiconductor parameter analyzers, or oscilloscopes, they can obtain accurate results simply and quickly. This application note highlights some of the most commonly performed tests, the challenges associated with them, and how Keithley SMU instruments can simplify the testing process, especially when integrated into a Keithley Parametric Curve Tracer (PCT) configuration.

Background on Power Device Characterization

The switching power supply is one common electrical circuit element used in power management products. In its simplest form (**Figure 1**), its main components include a semiconductor such as a power MOSFET, a diode, and some passive components, including an inductor and a capacitor. Many also include a transformer for electrical isolation between the input and output. The semiconductor switch and diode alternatively

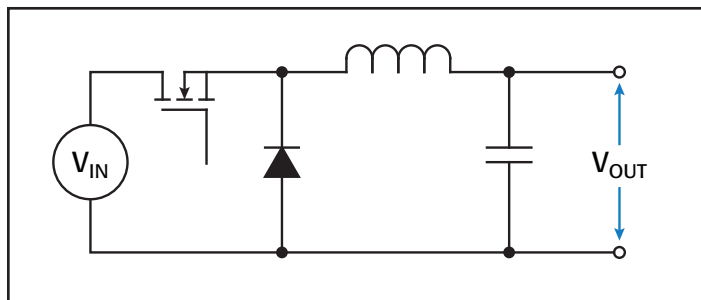

Figure 1. A simple schematic of a type of switching power supply.

switch on and off at a controlled duty cycle to produce the desired output voltage.

When evaluating energy efficiency, it's important to understand the *switching loss* (energy loss that occurs during the short periods when the device is changing states) and *conduction loss* (energy losses that occur when the device is either on or off). Keithley SMU instrument-based solutions can help test engineers evaluate the device parameters that affect conduction loss.

Semiconductor devices are often used to ensure circuit protection. For example, some thyristor devices are used for overvoltage protection. To achieve that objective, such devices must trigger at the appropriate intended voltage and current, must withstand the intended voltage, and must behave in circuit with minimal current draw. High power instrumentation is required to qualify these devices properly.

This note focusses on the characterization of static power device parameters.¹ These parameters can be divided into two broad categories: those that determine the performance of the device in its ON state and those that determine the performance in its OFF state. **Table 1** lists common ON-state and OFF-state parameters for several power semiconductor devices that Keithley SMU instruments support. Many tests involve the use of multiple SMU instruments. Keithley's ACS Basic Edition software simplifies the test configuration by managing the configuration and data collection of all SMU instruments in the test system. Unlike general-purpose start-up software, ACS Basic Edition is designed specifically for semiconductor device characterization and includes a library of tests; users can focus on the test and device parameters rather than the SMU instrument configuration.

¹ Tektronix solutions are available for transient characterization of power devices. For more information, visit www.tek.com.

Table 1. Common power semiconductor devices and tests.

Test Category	Devices and Tests					Keithley SMU I-V Capability
	Diode	MOSFET	BJT	IGBT	Thyristor-Class Devices (e.g., SCR, Triac)	
ON-state	V_F-I_F	$V_{DS}-I_D$ V_{TH} $V_{GS}-I_D$ $R_{DS(on)}$	$V_{CE}-I_C$ Gummel plot	$V_{CE}-I_C$ $V_{GE}-I_C$	V_T I_H I_L	Voltage: -40V to +40V Current: Up to 100A (pulse)
OFF-state	I_R	I_{GSS} I_{DSS} BV_{DSS} BV_{DG}	I_{CEO} I_{CES} BV_{CES} BV_{CEO} BV_{CBO}	I_{CEO} I_{CES} BV_{CES} BV_{CEO}	V_{bo} V_{DRM} V_{RRM}	Voltage: -3kV to +3kV Current: Down to 1fA

The test results included in this note were acquired using ACS Basic Edition software, which is included in our PCT configuration.

ON-State Characterization

ON-state characterization is typically performed using a high current instrument capable of sourcing and measuring low-level voltages. If the device has three terminals, then a second SMU instrument is used at the device control terminal to place the device in the ON state. For a typical configuration for characterizing the ON-state parameters of a power MOSFET, see *Figure 2*.

Keithley SMU instruments cover a wide range of currents for power semiconductor devices. Series 2600A and 2600B System SourceMeter SMU instruments include at least 1.5A DC and 10A pulse capability for DC characterization. For very high current devices, two Model 2651A High Power SourceMeter SMU instruments can be used in parallel to generate current pulses up to 100A.

Let’s examine the configuration details and measurement challenges of a few ON-state parameters.

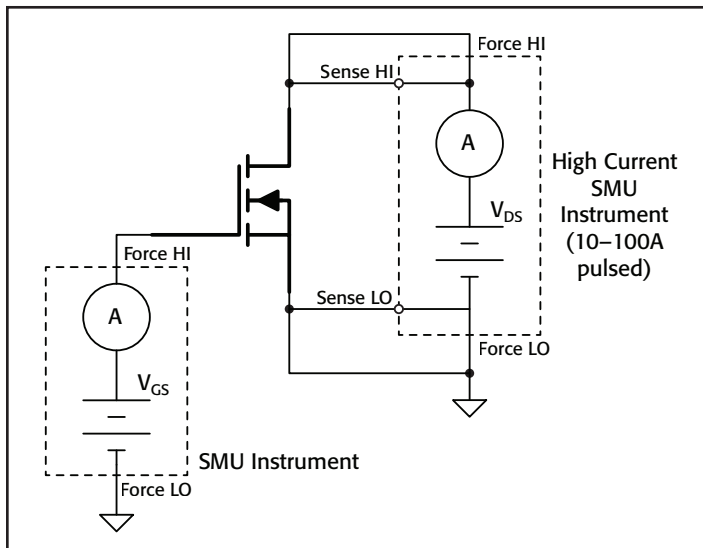

Figure 2. Typical SMU configuration for ON-state characterization of power devices.

Output characteristics

One of the most readily recognizable set of test results for a semiconductor device is a plot of its output characteristics. Output characteristics are normally shown in graphical form on the device’s data sheet and depict the relationship between the output voltage and current. For a gated power semiconductor switch, such as a MOSFET, IGBT, or BJT, output characteristics are commonly referred to

as the “family of curves.” *Figure 3* shows the results for a power IGBT as generated by ACS Basic Edition software.

Pulsed testing is common in power semiconductor test because DC testing can cause the device to self-heat, which can alter the measured characteristics. Implementing a pulsed test with multiple SMU instruments requires precise control of the timing of source adjustments and measurements and is often coordinated by means of a computer program. For consistent results, it is important to validate the system. This can be done by sourcing a single pulse through the system and measuring the response at the device. Capturing the complete pulse waveform as a function of time allows selecting appropriate source and measure delays so that the device turns on properly and measurements are made after the system is settled. The high speed A/D converters in Series 2650A High Power System SourceMeter SMU instruments are useful for monitoring the voltages and currents at the device as they relate to time. A diagnostic feature in ACS Basic Edition 2.0 software allows capturing the pulse shape of a single point in the family of curves easily. *Figure 4* depicts the results of a pulse transient characterization of collector voltage and current vs. time of an IGBT. For this particular example, delaying the measurement 100µs after the start of the pulse ensures the system has settled

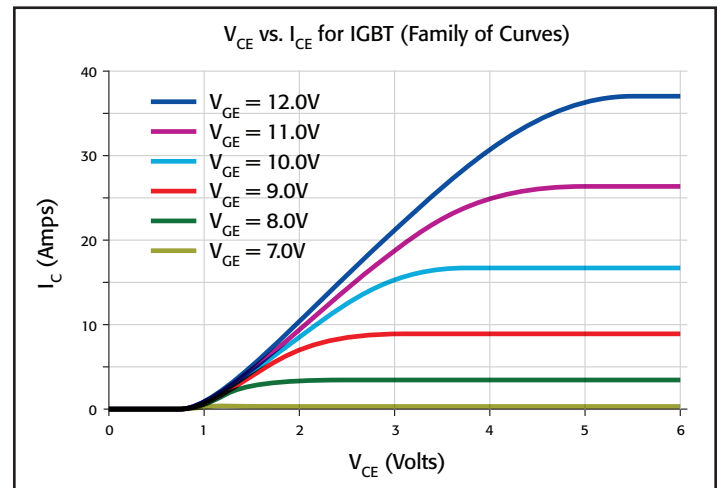

Figure 3. Measured output characteristics for commercially available IGBT.

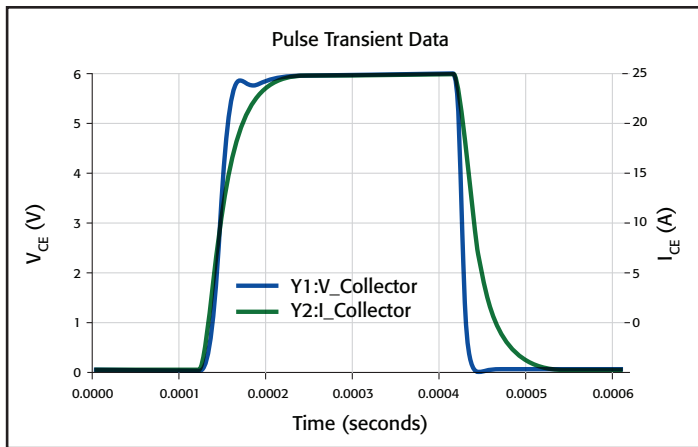

Figure 4. Pulse transient data of collector voltage and current vs. time for an IGBT.

prior to measurement, allowing for more consistent results between tests.

Power semiconductor devices are often high gain devices; oscillation is common when characterizing such devices and will result in erratic measurements. The high speed A/D converters in the Series 2650A SMU instruments and the pulse transient feature of ACS Basic Edition 2.0 software are useful for verifying the presence of oscillation. Resolving this oscillation involves adding a resistor in series with the device control or input terminal, for example, the gate of a MOSFET or IGBT. The Keithley Model 8010 High Power Test Fixture easily accommodates the addition of a discrete resistor.

ON-state voltage

The semiconductor device's ON-state voltage directly impacts the conduction loss. Examples of ON-state voltages include the forward voltage of a power diode (V_F), the ON-state saturation voltage of a BJT or an IGBT (V_{CEsat}), and the ON-state voltage of a thyristor (V_T). Power consumed by or lost in the device is equal to the product of the ON-state voltage and the load current. This power is not delivered to the device. Typically, device manufacturers want to characterize how the ON-state voltage and, by extension, the conduction loss, varies with temperature and load current. Keithley SMU instruments are commonly used in these characterizations.

To measure the ON-state voltage, the high current SMU instrument is configured to output current to the device and measure voltage. For BJTs and IGBTs, a second, lower-power SMU instrument is used at the base or gate terminal to place the device in the ON state. Because power semiconductors are typically high current devices, ON-state voltage is generally measured using a pulsed stimulus to avoid any change in device parameters as a result of device self-heating due to a DC test current.

Two key elements help ensure a successful ON-state voltage test: (1) accurate voltage measurement and (2) proper cabling and connections. Accurate voltage measurements are

crucial because ON-state voltage varies with temperature. For instance, a few millivolts of difference in the forward voltage of a power diode can indicate a change of several degrees in the temperature at the device. High speed A/D converters in the Keithley Model 2651A High Power System SourceMeter SMU Instrument let it make very accurate voltage measurements at $1\mu s$ intervals with pulse widths as short as $100\mu s$.

Proper cabling and connections are equally key to minimizing voltage errors. For power diodes, BJTs, and IGBTs, typical test currents can range from 100mA to tens of amps while ON-state voltages of 1–3V are very common. Thyristors are ideal for use in ultra-high-power applications because they have very low ON-state voltages ($<2V$) while conducting currents that could be greater than 100A. During testing, such high currents can generate voltage drops across test leads and test lead connections between the instrument and the DUT. These additional voltages create errors in the voltage measurement. Four-wire or Kelvin connections eliminate most of these voltage errors from the measurement by using separate test leads for the voltmeter. Minimal current flows in these leads, creating virtually no voltage drops between the instrument and DUT, so the instrument measures the voltage seen at the DUT.

The use of low inductance cables helps ensure good pulse fidelity (i.e., short rise and fall times) when testing high current devices, which provides more time for measurement within a given pulse width. The Model 2651A High Power System SourceMeter SMU Instrument comes with a specialized low resistance, low inductance cable assembly appropriate for generating $100\mu s$ pulses at 50A.

Transfer characteristics

A device's transfer characteristics allow evaluating its transconductance and therefore its current carrying capability. Transfer characteristics have an indirect relationship to determining switching time and estimating switching losses. The transfer characteristics are often monitored vs. temperature in order to gauge temperature's effect on the device's maximum current handling capability. Two SMU instruments are required for measuring the transfer characteristics: one sweeps the input voltage on the control terminal of the device and the second biases the output terminal and measures the output current. Typical transfer characteristic measurements include the gate voltage vs. drain current plot for a MOSFET ($V_{DS}-I_D$), the gate voltage vs. collector current plot for an IGBT ($V_{GE}-I_C$), and the Gummel plot for a BJT (V_{BE} vs. I_C, I_B).

In some cases, a wide range of output current is measured. This is especially true for the Gummel plot of a BJT, where several orders of magnitude of current are traversed. In these cases, the Model 2651A is very useful because it can measure currents from the nanoamp range up to 50A. **Figure 5** depicts a Gummel plot generated using a Model 2651A on the collector and a Model 2636B on the base.

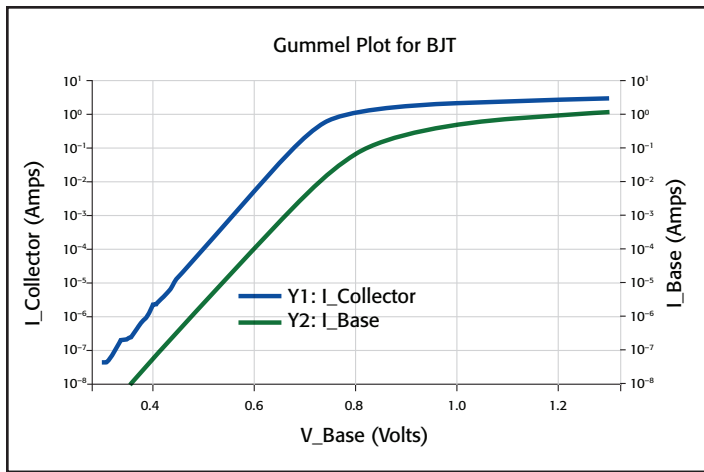

Figure 5. Gummel plot for typical power BJT generated using Keithley Models 2651A and 2636B SMU instruments.

ON-resistance

The figure of merit for a power MOSFET is the product of ON-resistance ($R_{DS(on)}$) and gate charge (Q_G). The ON-resistance is the key determinant of the conduction loss of the power MOSFET. The conduction loss is equal to $I_D * R_{DS(on)}$. Newer devices have ON-resistances in the range of a few milliohms to tens of milliohms at high current. This requires very sensitive voltage measurement capability at the drain terminal. Measuring ON-resistance requires the use of two SMU instruments: one SMU instrument drives the gate into the ON state and a second SMU instrument pulses a defined current at the drain and measures the resulting voltage. The ON-resistance is calculated using Ohm's Law and the programmed drain current and measured drain voltage. Such a calculation can be automatically configured in software.

ON-resistance is often characterized as a function of drain current or gate voltage. Using software, both SMU instruments can be triggered and swept so that this measurement is performed within a single test. **Figure 6** shows the calculated $R_{DS(on)}$ vs. drain current results. This was all completed during a single run of the $R_{DS(on)}$ test. For very high current devices, two Model 2651As can be used in parallel to generate current pulses up to 100A. ACS Basic Edition software manages the configuration of both SMU instruments and the data collection.

ON-resistance increases with breakdown voltage, so any process adjustments made to increase the breakdown voltage will involve later testing of ON-resistance in order to assess the overall impact of process changes. Obtaining more efficient devices at higher voltages is one of the drivers for further research on SiC and GaN devices, which offer ON-resistances smaller than silicon devices' at high withstand voltages.

OFF-State Characterization

To gain an adequate understanding of overall product efficiency, the impact of the device on the overall circuit when the device

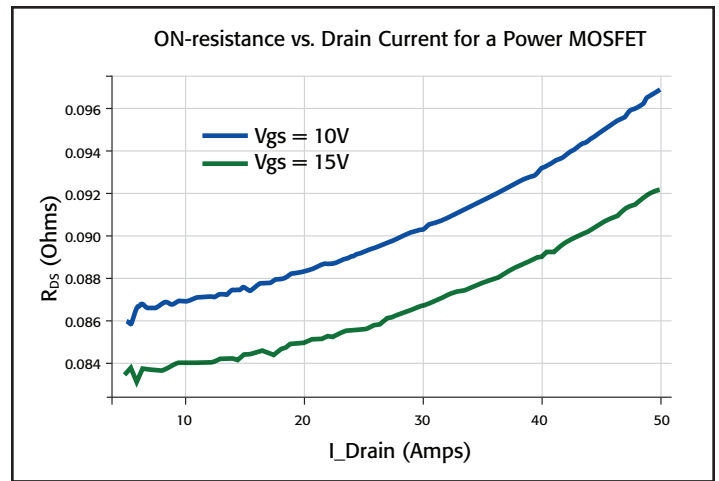

Figure 6. Results for ON-resistance of a power MOSFET as measured as a function of drain current for two gate voltages.

is turned off must be investigated. For high power devices, OFF-state characterization often involves the use of a high voltage instrument capable of sourcing hundreds or thousands of volts and measuring small currents. OFF-state characterization is often performed between two device terminals (regardless of the total number of device terminals), so a single SMU instrument is often sufficient to perform the measurement. However, an additional SMU instrument can be used to force the device into its OFF state or to add certain stress to certain terminals.

Keithley SourceMeter SMU instruments cover a wide range of voltages and currents for characterizing the OFF state of power semiconductor devices. The Model 2635B and 2636B SMU instruments offer 200V characterization with current measurement capability down to the femtoamp level. The Model 2657A SMU instrument extends high voltage characterization to 3kV while providing very low current measurement resolution and accuracy.

Two primary DC tests are performed when the device is off: breakdown voltages and leakage currents. Let's consider these individually.

Breakdown voltages

A device's OFF-state breakdown voltage determines the maximum voltage that can be applied to it. The primary withstand voltage of interest to power management product designers is the breakdown voltage between drain and source of a MOSFET or between the collector and emitter of an IGBT or BJT. For a MOSFET, the gate can be either shorted or forced into a "hard" OFF state, such as by applying a negative voltage to an n-type device or a positive voltage to a p-type device. This is a very simple test that can be performed using one or two SMU instruments. The lower power SMU instrument is connected to the gate and forces the transistor off. It can force 0V for a gate shorted test or force a user-specified bias voltage. A high voltage SMU instrument, such as the Model 2657A, forces current into the drain and measures the resulting drain voltage.

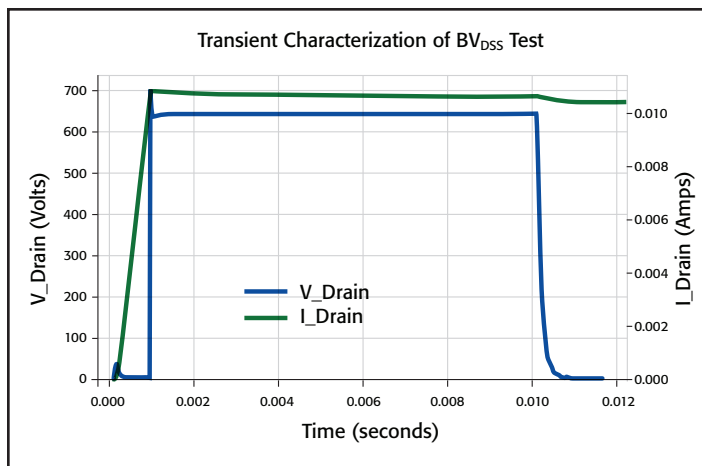

Figure 7. Transient capture of voltages and currents of BV_{DSS} test using the Model 2657A's fast A/D converter. Sampling interval is $10\mu s$.

Most MOSFETs typically have breakdown voltages higher than the value specified on the data sheet. Therefore, it is useful to define the voltage limit of the drain SMU instrument to a value higher than the specified breakdown voltage. Additionally, as the drain terminal is driven closer and closer toward avalanche, the behavior of the currents and voltages of the device under test (DUT) may begin to change. These cases can take advantage of the high speed A/D converters of the Series 2650A SMU instruments. Without the need for any extra equipment, it's possible to catch a quick look at both the transient behavior of current and voltage at the DUT. *Figure 7* is an example of transient characterization of a test of the breakdown voltage between drain and source of a commercially available 600V silicon power MOSFET. The Model 2657A is used to pulse a current into the MOSFET and then measure the voltage and current at $10\mu s$ intervals. The plot shows that the device actually breaks down at approximately 680V.

Another way of characterizing breakdown voltages involves forcing a voltage across the terminals of interest (e.g., drain and source of a MOSFET) and measuring the resulting current. The breakdown voltage is defined as the voltage at which the current exceeds a specified threshold, for example, 1mA. Limit the maximum current in order to prevent destruction of the device during testing. Unlike traditional curve tracers and power supplies, Keithley SourceMeter SMU instruments include built-in programmable features to limit the maximum voltage and current to the device precisely and quickly. As with any protection device, the limit control of the SMU instrument has a finite response time. Some devices may have extremely fast and hard breakdown behavior in which the device impedance changes by several orders of magnitude in a very short period. When the device breaks down faster than the SMU instrument can respond, use series resistors to limit the total maximum current through the device.

Safety must be one of the first considerations for high voltage characterization of power semiconductor devices. Keep

in mind the voltage ratings for all terminals, connectors, and cables. For example, Keithley SourceMeter SMU instruments are electrically floating, which means that measurement common is not tied to protective earth (safety ground). Unless the user ties measurement common to safety ground, then he must take high voltage precautions at *all* terminals if the SMU instrument can generate more than 42V.

When configuring a test system, it's important to protect the operator from electric shock. One primary way to do this is to use a safe test enclosure that surrounds the DUT and any exposed connections. The Keithley Model 8010 High Power Test Fixture permits safe testing of packaged high power semiconductor devices at up to 3kV. Pairing a safe enclosure with a safety interlock also minimizes risk of electric shock when the user changes test connections. Keithley SMU instruments are equipped with a safety interlock; when properly installed, this interlock ensures that the hazardous voltages are disconnected whenever a user opens the test fixture or accesses the wafer in a probe station.

In addition to protecting the operator, it is also important to consider the interactions between all the instruments connected to the device terminals. If a lower voltage SMU instrument is connected to the device during a breakdown characterization, a device fault can result in high voltage being present across this lower voltage SMU instrument. Keithley's Model 8010 High Power Test Fixture includes built-in protection to protect the lower voltage SMU instrument in such applications.

Leakage currents

Leakage current is the level of current that flows through two terminals of a device even when the device is off. It factors into the standby current of the end product. In most cases, temperature and the voltage across the terminals of interest will affect leakage current. Minimizing leakage current minimizes power loss when the device is off. This power is consumed by the device and is not output to the load and therefore contributes to power inefficiency. When using a transistor or diode to switch or rectify, it's important to make a clear distinction between ON and OFF states; therefore, a lower leakage current means having a better switch.

While testing a device's OFF state, it is generally desirable to test the gate leakage current and drain or collector leakage current. For power devices, these values are typically within the nanoamp and microamp ranges, so they can be measured using the sensitive current measurement capability of Keithley SMU instruments. This capability can be greatly beneficial when testing devices made of wide bandgap materials such as silicon carbide, gallium nitride, and aluminum nitride, which typically have higher breakdown voltages and lower leakage currents than do silicon devices. *Figure 8* is a plot of OFF-state drain voltage vs. drain current results for a commercially available SiC power MOSFET.

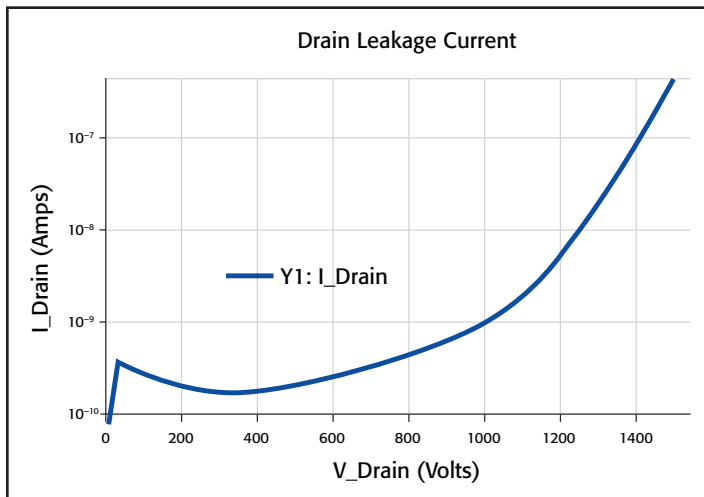

Figure 8. A look at the drain leakage current as the drain voltage is swept while the transistor is in the OFF state.

Triaxial cables are essential to achieving accurate low current measurements in part because they permit carrying the guard terminal. Guarding eliminates the effect of system leakage currents by routing them away from the measurement terminal. Additionally, guarding reduces settling time in high voltage applications by virtually eliminating the need to charge the cable capacitance. Using a guarded test fixture or probe allows the benefits of guarding to be extended to the DUT.² Keithley offers triaxial cables and connections for all its SMU instruments that are tailored for low current measurements, such as the Model 2636B and Model 2657A SMU instruments. The specialized high voltage triaxial cables for the Model 2657A allow measurements at 3kV with 1fA resolution. The Model 8010 test fixture includes guarded connections to the device test board to permit current measurements down to tens of picoamps.

² For more details on guarding, review Keithley Application Note #3163, [Creating Multi-SMU Systems with High Power System SourceMeter SMU Instruments](#).

Electrostatic shielding is another important consideration for low current measurements. An electrostatic shield is a metal enclosure that surrounds the circuit and any exposed connections. The shield is connected to measurement common to shunt electrostatic charges away from the measurement node. When testing devices within the Model 8010 High Power Test Fixture, the test fixture chassis serves as an electrostatic shield.

Finally, system validation is important for low current characterization to ensure that the measurement is settled. Settling time increases as the expected current decreases. Keithley products have auto delay settings that set reasonable delays to achieve good measurements while taking the instrument's settling characteristics into account. However, to account for any unguarded system capacitance, perform a measurement validation by stepping voltage and measuring the resulting current through the system. Use the results from the validation to set additional source and measure delays in order to achieve consistent measurements.

Conclusion

Keithley SourceMeter SMU Instrument solutions can be used with ACS Basic Edition software to provide a comprehensive solution for testing high power semiconductor discrete devices. ACS Basic Edition includes a library of tests for a variety of power devices including FETs, BJTs, IGBTs, diodes, resistors, and thyristors. Additionally, Keithley has the appropriate cabling accessories and test fixtures that allow safe, accurate, and reliable testing. Although these instruments and accessories can be purchased separately, they are also available as part of Keithley's Parametric Curve Tracer Configurations. Refer to Keithley's website (www.keithley.com) or contact your local Keithley representative for further information or system configuration assistance.



A Greater Measure of Confidence

Specifications are subject to change without notice. All Keithley trademarks and trade names are the property of Keithley Instruments, Inc. All other trademarks and trade names are the property of their respective companies.