

HIOKI

New

POWER ANALYZER PW6001

Power measuring instruments



Improve Power Conversion Efficiency

Industry-Leading Accuracy and Maximum 12 Channels*

Hioki Power Analyzers Set Next Generation Standards for Power Efficiency Testing

CE

* When synchronizing two 6-channel models connected via optical link

Basic accuracy for power $\pm 0.02\%^{*}$

Achieving true power analysis

High accuracy, wideband, and high stability. The Hioki PW6001 combines the 3 important elements of power measurement and basic performance backed by advanced technology to achieve unsurpassed power analysis.



Strengthened resistance to noise and temperature fluctuations in the absolute pursuit of measurement stability

The custom-shaped solid shield made completely of finely finished metal and optical isolation devices used to maintain sufficient creepage distance from the input terminals dramatically improve noise resistance, provide optimal stability, and achieve a CMRR performance of 80 dB/100 kHz. Add the superior temperature characteristics of $\pm 0.01\%/^{\circ}\text{C}$ and you now have access to a power analyzer that delivers top-of-the-line measurement stability.

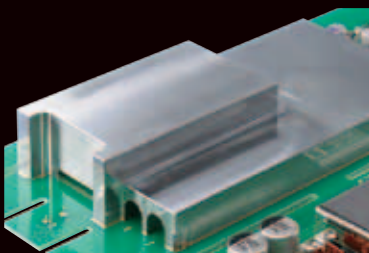

Solid shield

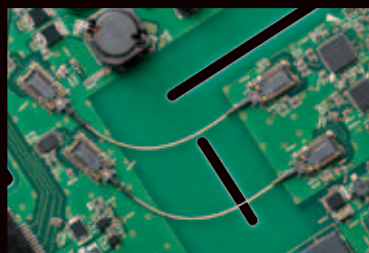

Optical isolation device

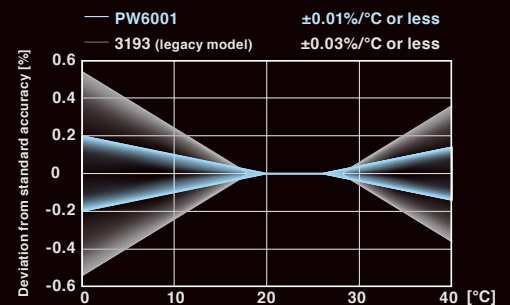

3x improvement in temperature characteristics compared to legacy model

* Unit accuracy only

TrueHD 18-bit converter* measures widely fluctuating loads with extreme accuracy

A built-in 18-bit A/D converter provides a broad dynamic range. Even loads with large fluctuations can be shown accurately down to tiny power levels without switching the range. Further, a digital LPF is used to remove unnecessary high-frequency noise, for accurate power analysis.

TrueHD
18-bit resolution

Conversion efficiency measurement during mode measurement without switching ranges

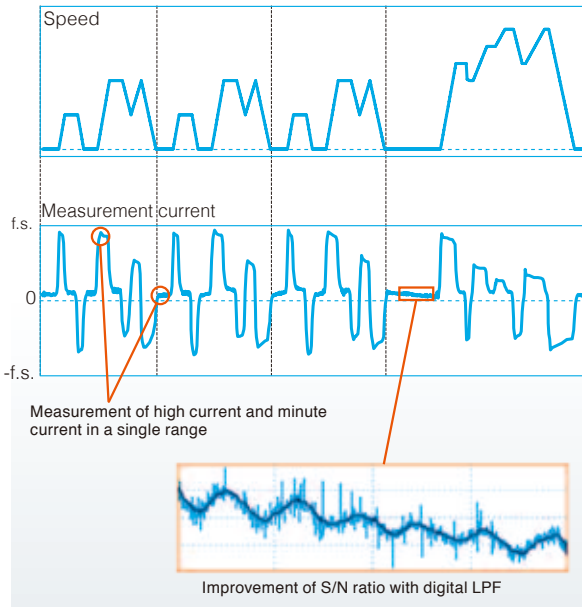

*True HD : True High Definition

DC accuracy is indispensable for achieving correct efficiency measurements

For example, when measuring the efficiency of a DC/AC converter, not only AC accuracy but also DC accuracy are equally important. With the PW6001, a DC measurement accuracy of $\pm 0.02\%$ rdg. $\pm 0.05\%$ f.s.* delivers correct and stable efficiency measurements.

$\pm 0.02\%$ rdg.
DC accuracy

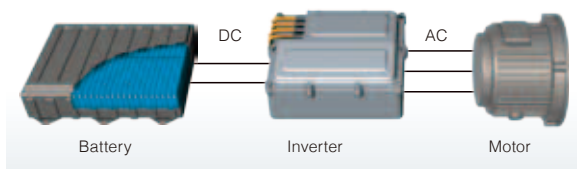

Accuracy of efficiency is determined by AC accuracy and DC accuracy.

*Unit accuracy only

Fast, simultaneous calculation functions achieved with Power Analysis Engine II

All measurements, including period detection, wideband power analysis, harmonic analysis, and waveform analysis, are digitally processed independently and with no effect on each other. Fast calculation processing is used to achieve a data update speed of 10 ms while maintaining maximum accuracy.

Accuracy guaranteed @ 10ms data update

Fast, simultaneous processing

Zero-cross filter

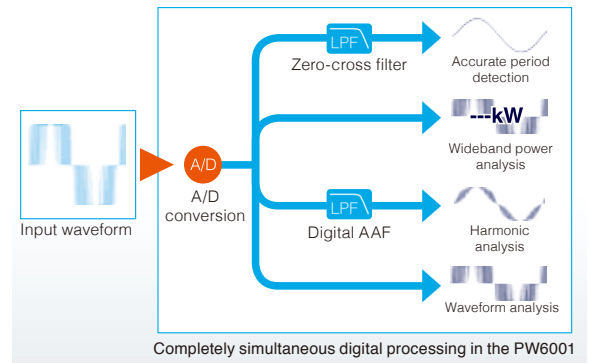

AAF: Antialiasing filter
Filter for preventing aliasing distortion in harmonic calculations

Get a combined accuracy of $\pm 0.07\%$ rdg. even with current sensor

Add $\pm 0.05\%$ rdg. accuracy of the current sensor to the PW6001's basic accuracy of $\pm 0.02\%$ rdg. to achieve top-of-the-line accuracy of $\pm 0.07\%$. Choose from a diverse array of sensors to cover very small currents from 10mA up to large 1000A loads.

High-accuracy current sensors



High-accuracy AC/DC current sensors

*Effective measurement range

DC, 0.1 Hz to 2 MHz frequency bandwidth

Broad and flat frequency characteristics

Power measurements across wide bandwidths are required for supporting high-speed switching devices such as SiC. Compared even to the Hioki 3390 Power Analyzer, the PW6001 is engineered with 10x the frequency band and sampling performance.



High-speed sampling of 5 MS/s for true frequency analysis

Measurements based on sampling theorem are required to perform an accurate power analysis of PWM waveforms. The Hioki PW6001 features direct sampling of input signals at 5 MS/s, resulting in a measurement band of 2 MHz. This enables analysis without aliasing error.

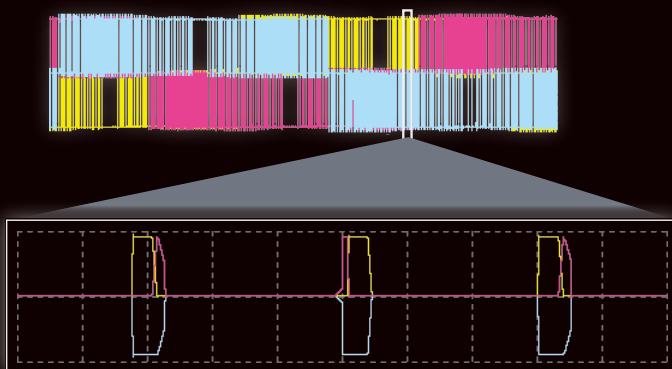

Dual sampling

Achieve independent sampling of waveform recordings and power analysis. Sampling for waveform recordings can be set freely, while maintaining a power analysis of 5 MS/s.

Large capacity waveform storage

Enjoy 1 Mword x 6 channels of data storage for voltage and current, making it possible to record signals for up to 100 seconds (at 10 kS/s).

Analyze waveforms without an oscilloscope

In addition to voltage and current waveforms, torque sensor and encoder signals can also be displayed simultaneously. The PW6001 is also built in with triggers, pre-triggers, other triggers convenient for motor analysis such as for PWM waveforms, as well as encoder pulse triggers.

Waveform analysis function

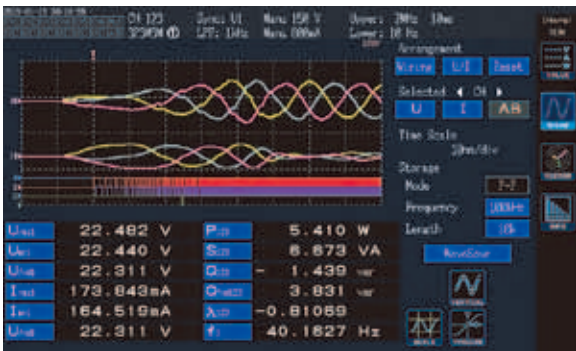

Wideband current probes supported

When combined with the HIOKI CT6700, it is also possible to measure minute currents of 1 mA. This is perfect for observing leakage current waveforms in inverters.



Wideband current sensors



Built-in current sensor phase shift function

For accurate power measurement, both amplitude accuracy and phase accuracy specifications are important. Use of the phase shift function allows improvements in measurement accuracy for both high-frequency and low power factor signals. Enter the calibration value for the current sensor to optimize accuracy.

Current sensor phase shift function

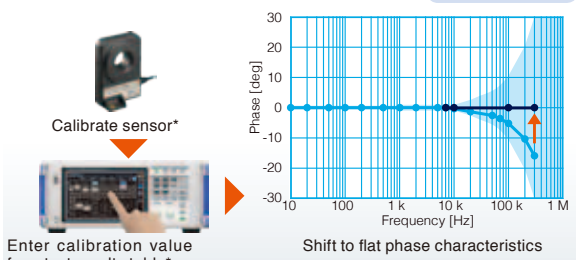

*Calibration and test results tables can be purchased separately.

Harmonic analysis up to 1.5 MHz

Wideband harmonic analysis is provided as a standard feature to a max. 100th order for fundamental frequencies 0.1 Hz to 300 kHz and an analysis band of 1.5 MHz. Analysis of fundamental waves in motors and measurement of distortion rate in the transmission waveforms for wireless power supplies are now possible.

Wideband mode harmonic analysis

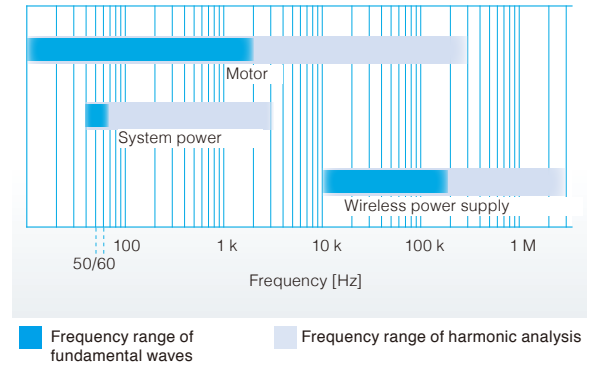

Unrestricted conversion of phase voltage and line-to-line voltage

Use of the Δ-Y conversion function allows for the calculation of phase voltage and phase power of 3-phase motors whose neutral points cannot be accessed. Further, the Y-Δ conversion function lets you calculate 3-phase 4-wire line-to-line voltage.

Δ-Y conversion

Y-Δ conversion

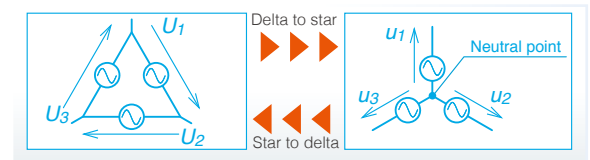

Digital LPF for displaying the waveform you want to view

Select a cutoff frequency for the measurement target. Digital LPF greatly reduces noise to let you display the waveform you want to view.

Digital LPF

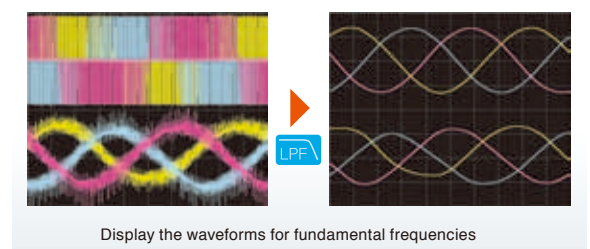

Specially designed for current sensors to achieve highly precise measurement

With direct wire connection method

The wiring of the measurement target is routed for connecting to the current input terminal. However, this results in an increase in the effects of wiring resistance and capacitive coupling, and meter loss occurs due to shunt resistance, all of which lead to larger accuracy uncertainty.

Measurement example using the direct wire connection method

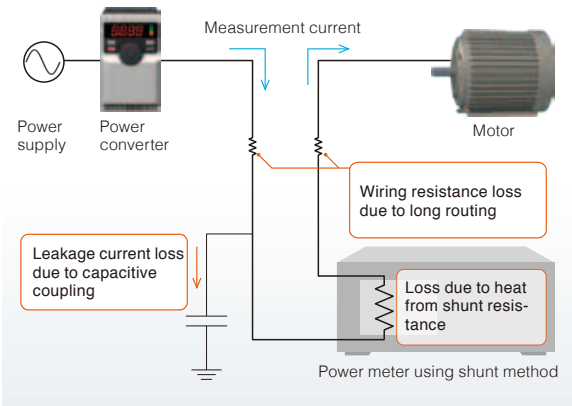

Advantages of current sensor method

A current sensor is connected to the wiring on the measurement target. This reduces the effects of wiring and meter loss, allowing measurements with wiring conditions that are close to the actual operating environment for a highly efficient system.

High-accuracy current sensors

Measurement example using the current sensor method

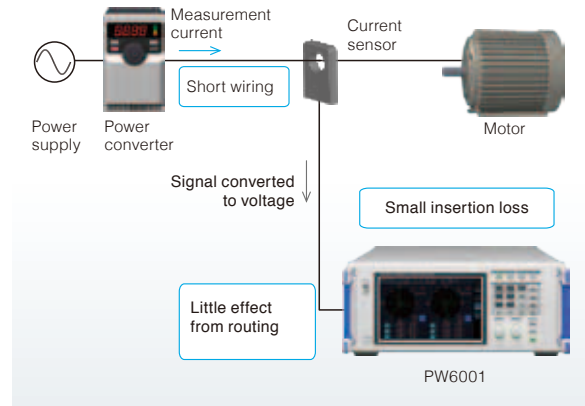

Compared to the direct wire connection method, measurement with conditions closer to the actual operation environment of a power converter is achieved.

Highly intuitive user interface

Seamless operability

Time spent on operations is reduced, to allow focused concentration on analysis.

Dual knobs

Connection confirmation screen

Handwritten memo

On-screen keypad



Dual knobs for vertical/horizontal manipulation of waveforms



Wiring confirmation function, to avoid wiring mistakes



Enter handwritten memos on the screen, or use the onscreen keypad



9-inch touch screen with soft keypad

Synchronization function for real-time connection of 2 units at a maximum distance of 500 m

Build a 12-channel power meter using “numerical synchronization”

For multi-point measurements, use the numerical synchronization function to transfer power parameters from the slave device to aggregate at the master in real-time, essentially enabling you to build a 12-channel power meter

Numerical synchronization
Max. 12 channels

Master

Display power parameters for master and slave

Slave

Transfer power parameters other than waveform and harmonic data

- Real-time display of slave instrument measurement values on master instrument screen
- Real-time efficiency calculations between master/slave
- Save data for 2 units on recording media in master instrument

Simply transfer waveforms with “waveform synchronization”

Achieve real-time* transfer of 5 MS/s 18-bit sampling data. Measurement waveforms on the slave instrument are displayed without modification on the master unit, paving the way for new applications for power analyzers, such as measurement of the voltage phase difference between two separate devices.

Waveform synchronization

Master

Display max. 6 channels of waveforms for master and slave

Slave

Transfer waveform data for max. 3 channels

- Real-time display of slave instrument waveforms on master instrument screen
- Harmonic analysis and fundamental wave analysis for master instrument and slave instrument
- Simultaneously measure waveforms on master device while using the slave to trigger

*For both master instruments and slave instrument, waveform synchronization operates only when there are 3 or more channels. Max. ±5 sampling error

Models with motor analysis & D/A output

(PW6001-11/-12/-13/-14/-15/-16)

Diverse motor analysis functions

Enter signals from torque meters and speed meters to measure motor power. In addition to motor parameters such as motor power and electrical angle, output signals from insulation meters and wind speed meters can also be measured.

Single Motor analysis

Dual Motor analysis

Independent input for motor analysis

ch A	Torque	Torque	Voltage/ Pulse
ch B	Encoder A phase signal	Torque	Voltage/ Pulse
ch C	Encoder B phase signal	RPM	Pulse
ch D	Encoder Z phase signal	RPM	Pulse
Measurement targets	Motor x 1	Motor x 2	Pyranometer/ anemometer and other output signals
Measurement parameters	Electric angle Rotation direction Motor power RPM Torque Slip	Motor power x 2 RPM x 2 Torque x 2 Slip x 2	Voltage x 2 & Pulse x 2 or Pulse x 4

D/A output supporting waveform output

Output analog measurement data at update rates of up to 10ms. Combine with a data logger to record long-term fluctuations, and use the built-in waveform output function to output voltage and current at 1 MS/s*.

D/A analog output
D/A waveform output

Analog output	Analog output x 20 channels
Waveform output	Waveform output x max. 12 channels* & analog output x 8 channels

* Varies according to the number of channels installed in the PW6001.

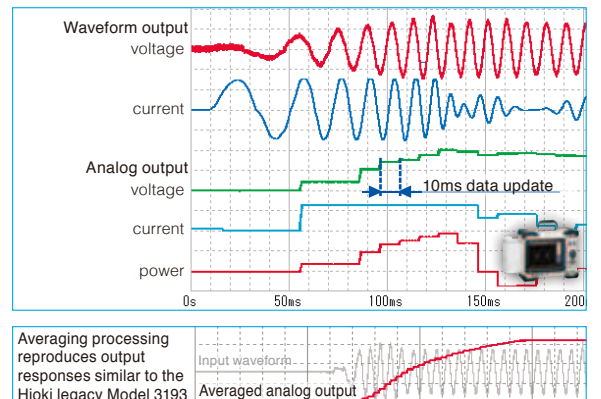

*During waveform output, accurate reproduction is possible at an output of 1 MS/s and with a sine wave up to 50 kHz.

Application 1

Conversion efficiency measurement of inverters with built-in SiC

- Key features**
- TrueHD 18-bit resolution
 - High-speed sampling 5 MS/s
 - Wideband mode harmonic analysis
 - Anti-noise stability
 - CMRR 80 dB/100 kHz
 - Current sensor phase shift function

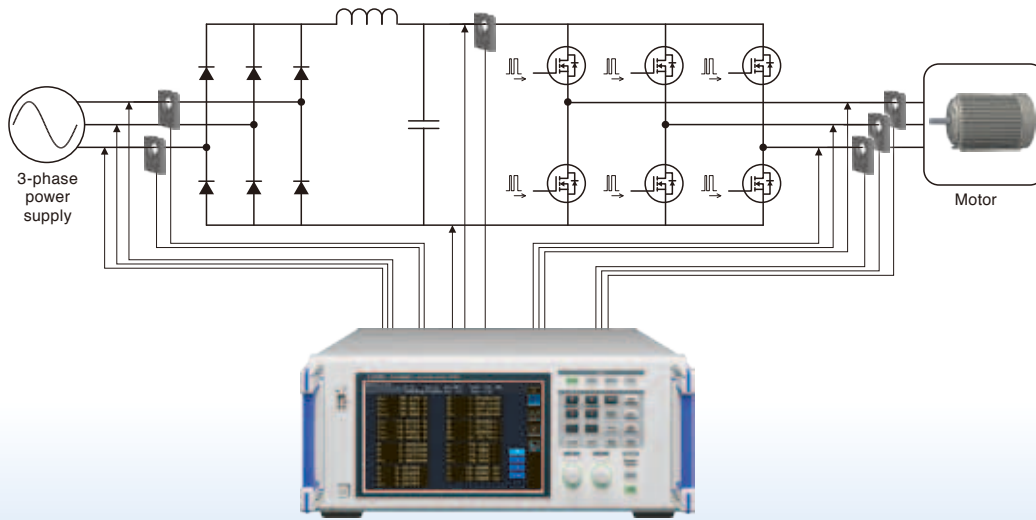

SiC measurement achieved with high resolution

High resolution is required for the high precision measurement of PWM waveforms for SiC semiconductors with low ON resistance. TrueHD 18-bit is achieved at a level of precision that has never been seen before.

TrueHD 18-bit resolution

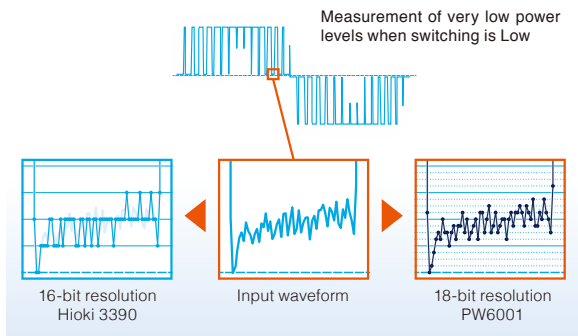

Simultaneous harmonic analysis for input/output

Analyze harmonic data that is synchronized to the fundamental waveforms of both the input and output of an inverter. A maximum of 6 systems can be analyzed simultaneously.

Max. 6 systems Simultaneous harmonic analysis

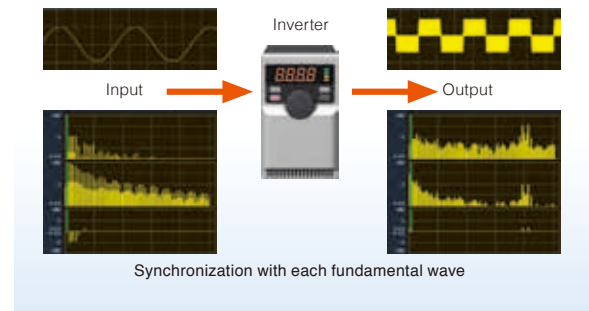

Detailed analysis of PWM waveforms

A cursor readout function*, zoom function*, and trigger/pre-trigger function, which are not available on the Hioki 3390, are built-in on this unit. You can use the touch screen and dual knobs for unrestricted analysis of waveforms.

Waveform analysis function

*Available soon.

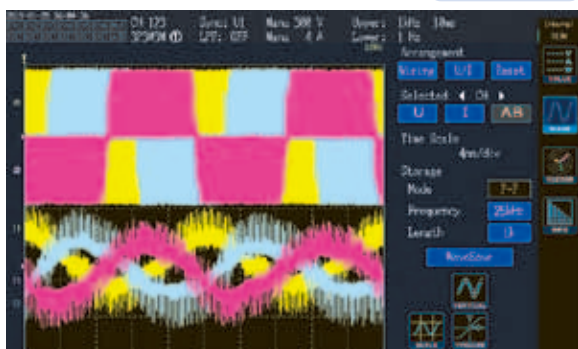

Line-to-line voltage waveform and line current waveform for 3-phase motor

Observe phase voltage waveforms

Use the Δ -Y conversion function to display the calculations for phase voltage at the waveform level from the line-to-line voltage of the motor, enabling you to analyze the harmonics of the phase voltage waveforms.

Δ -Y conversion

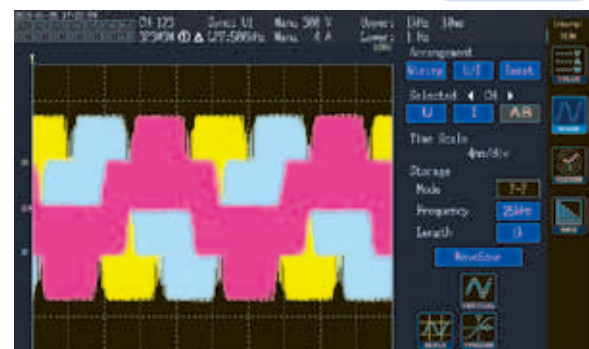

Phase voltage waveform using Δ -Y calculation

Application 2

Transmission efficiency of wireless power supplies

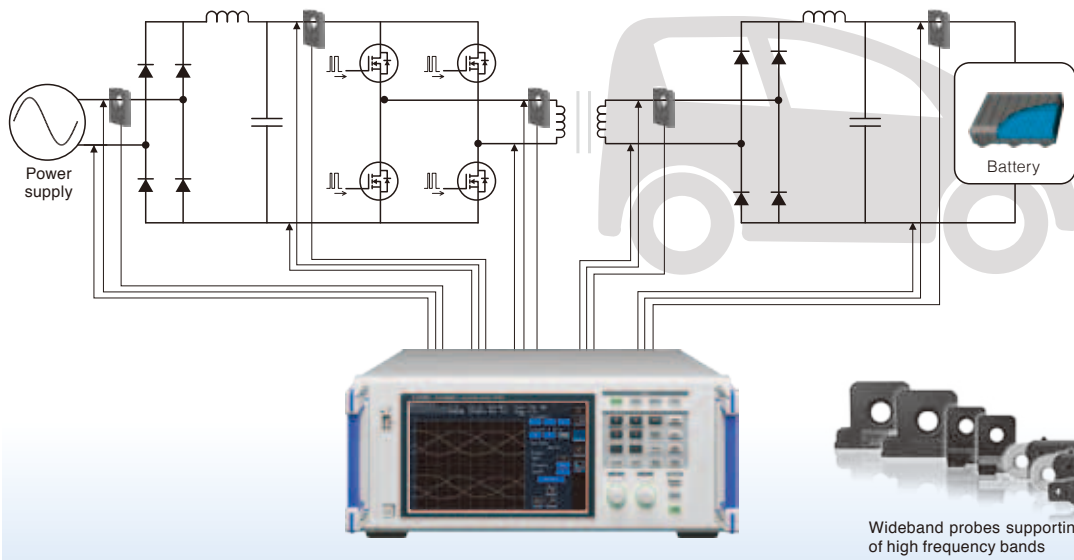

- Key features**
- 5MS/s high-speed sampling
 - Wideband mode harmonic analysis
 - Current sensor phase shift function
 - Wideband current sensors



Wideband probes supporting the measurement of high frequency bands

Harmonic analysis of transmission frequency

Measure the efficiency of wireless power supply devices such as those found in electric vehicles. Use of the wideband harmonic analysis function up to a fundamental wave of 300 kHz allows the analysis of waveform distortion rate and harmonic waves in the vicinity of 100 kHz used for wireless power transmission.

Wideband mode harmonic analysis

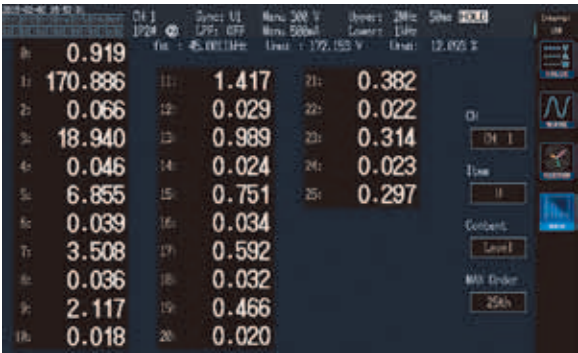

Accurate measurement of low power factor power

With wireless power supplies, the power factor drops due to the inductance component of the sending/receiving elements of energy. Use of the phase shift function in the PW6001 lets you accurately measure both high-frequency and lower power factor power.



Enter phase calibration values for each frequency to correct high-frequency phase characteristics.

Save data with a single touch

Use the [SAVE] key to save numerical data, and the [COPY] key to copy the screen. You can also enter comments on the saved data.



One-touch settings take you to measurement immediately

The built-in easy setup function allows you to simply select the type of measurement line and immediately start measurement using the automated optimum settings.

Easy setup



Application 3

EV/HEV motor analysis

Key features

Accuracy guaranteed @ 10ms data update

±0.02% rdg. DC accuracy

Flexible efficiency calculation

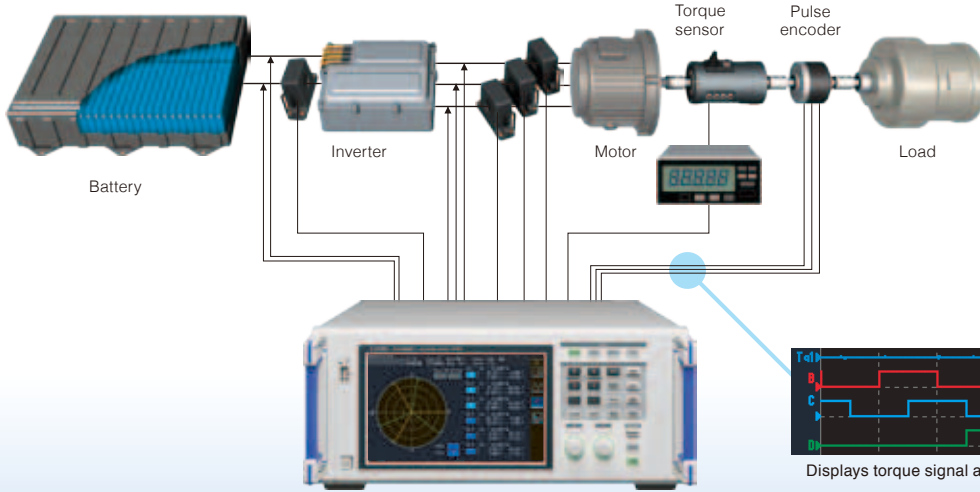

Displays torque signal and pulse encoder waveforms

Advanced electrical angle measurement function

The PW6001 features a built-in electric angle measurement function required for the measurement of motor parameters in high-efficiency synchronized motors and the analysis of vector control via dq coordinate systems. Make real-time measurements of phases for voltage and current fundamental wave components based on encoder pulses. Further, zero-adjustment of the phase angle when induced voltage occurs allows phase measurement at the induction voltage standard. Finally, the PW6001 can detect the forward/reverse from A phase and B phase pulses to enable 4-quadrant analysis of torque and RPM.

- Single motor analysis
- Motor electric angle measurement

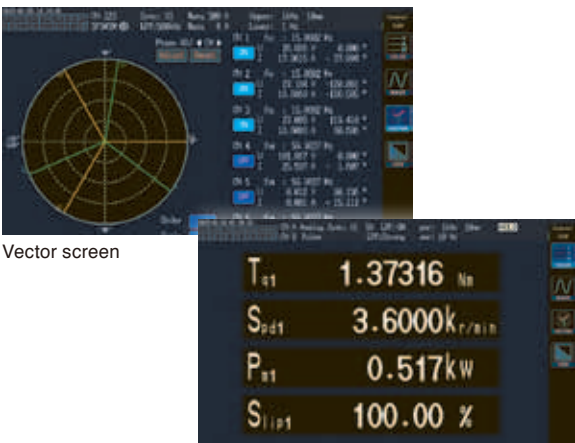

Vector screen

Torque, rpm, motor power, slip

Rackmount support

Optimal full rack size for test benches and production inspection lines

Full rack size



Fast 10 ms calculation of power in transient state

Measure power transient states, including motor operations such as starting and accelerating, at 10ms update rates. Automatically measure and keep up with power with fluctuating frequencies, from a minimum of 0.1 Hz.

Accuracy guaranteed @ 10ms data update

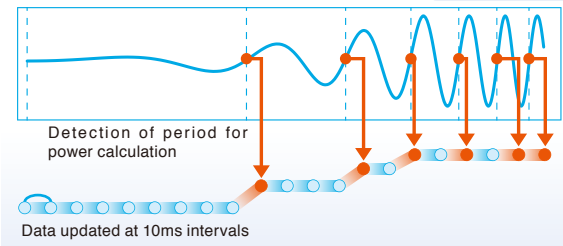

Automatic following of fundamental wave even if the frequency fluctuates, from low to high frequencies

Simultaneous measurement of 2 motor powers

The PW6001 is engineered with the industry's first built-in dual mode motor analysis function that delivers the simultaneous analysis of 2 motors. Simultaneous measurement of the motor power for HEV driving and power generation is now possible.

Dual Motor analysis

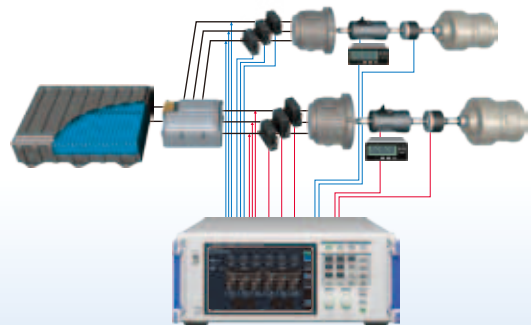

Example of 2 motor measurement

Application 4

Measuring the efficiency of PV power conditioners

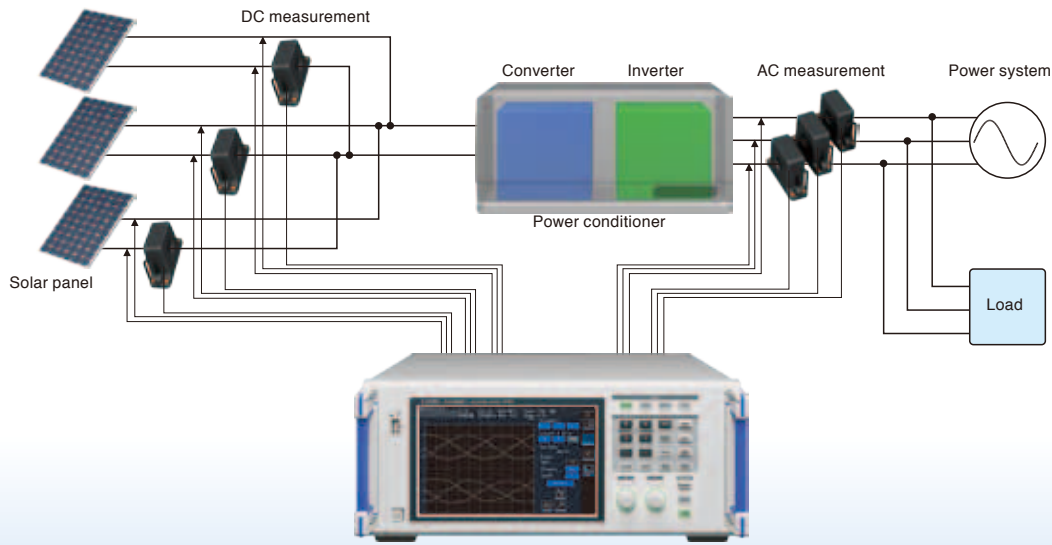

- Key features**
- ±0.02% rdg. DC accuracy
 - Various measurement parameters
 - Independent input for motor analysis
 - IEC mode harmonic analysis
 - Integration of purchased electricity

Assess efficiency and loss at a glance

In addition to the measurement of power generated by solar cells, efficiency rate of conditioners, loss, and the measurement of power from purchased electricity when power systems are linked are also possible at the same time.

- Integration of purchased electricity
- Flexible efficiency calculation

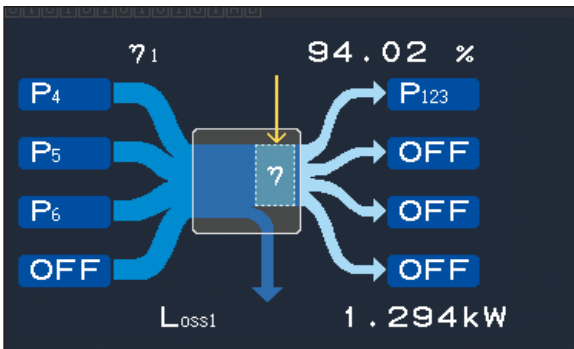

Harmonic analysis, important for linking systems

Conveniently evaluate according IEC61000-4-7 using the built-in IEC standard mode. You can also limit the number of THD calculations as required by the standard.

- IEC mode harmonic analysis

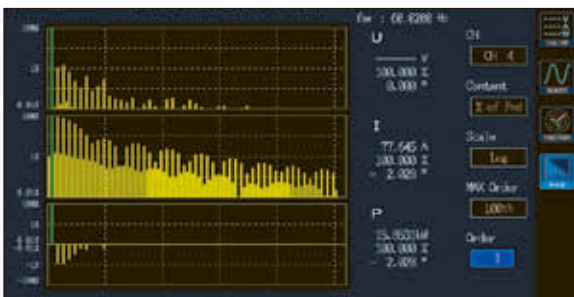

Confirm harmonic wave conditions on a bar graph at a single glance

Power conditioner testing

Parameters required for power conditioners, such as fundamental wave reactive power Qfnd, DC ripple rate, and 3-phase unbalanced rate, can be measured and displayed simultaneously. The required measurement data can be viewed at a glance, improving test efficiency.

- Various measurement parameters

P ₄	8.396kW	DC power (panel output)
P ₁₂₃	7.850kW	3-phase power (power conditioner output)
η_1	93.498 %	Conversion efficiency
U _{rf4}	0.212 %	Ripple rate
f ₁	50.3187 Hz	Frequency
U _{thd1}	2.390 %	Voltage total harmonic distortion
U _{unb123}	0.306 %	Unbalance rate
Q _{fnd123}	5.074 var	Fundamental wave reactive power

Measure output from environmental sensors

Using the independent input mode in the motor analysis function, you can measure the analog voltage signals from environmental testing devices such as insulation meters, thermometers, wind speed meters, and light meters, on a maximum of 2 channels. The signals can be recorded at the same time as power.

- Independent input for motor analysis

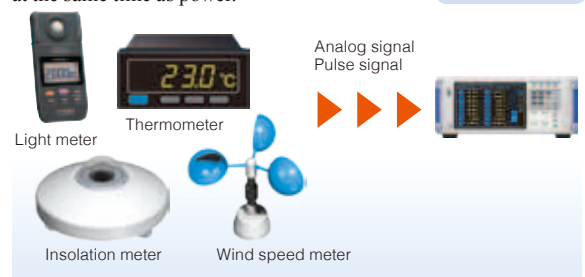

Application 5

Power conversion for wind power generation

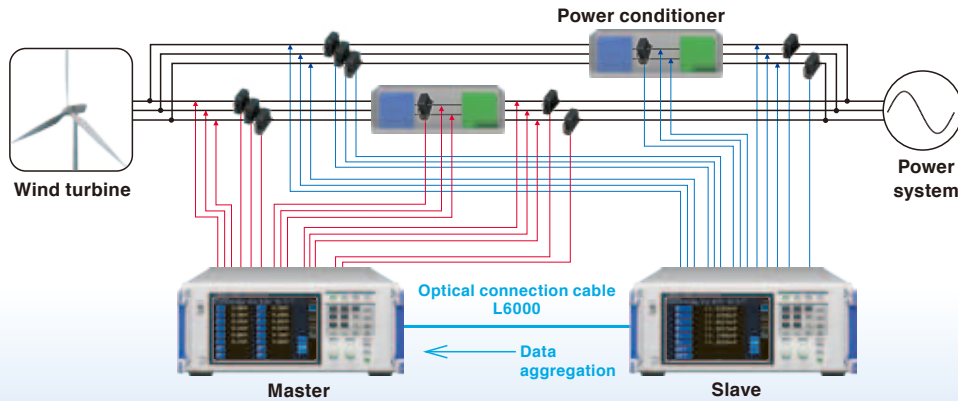

Key features

- Numerical synchronization Max. 12 channels
- Flexible efficiency calculation
- 2-system vector display

Simultaneous analysis of system and power generation

With the dual vector display, you can see the 3-phase balancing conditions for both the system and power generation at a glance.

2-system vector display



Measure the efficiency of power conditioners

By using the numerical synchronization function, you can take measurements with complete synchronization of power conditioners for 2 systems. All power parameters can be aggregated on the master instrument, and the efficiency for each or the overall efficiency can be calculated and displayed.

- Numerical synchronization Max. 12 channels
- Calculation of efficiency between 2 units

Application 6

Test and evaluate substations, plants and railroads



Measure phase difference between 2 separate points

Use the waveform synchronization function to measure the phase relationship between 2 points separated by a maximum distance of 500 m. Due to insulation with an optical connection cable, measurement can be performed safely even if the ground potential between the 2 points is not the same.

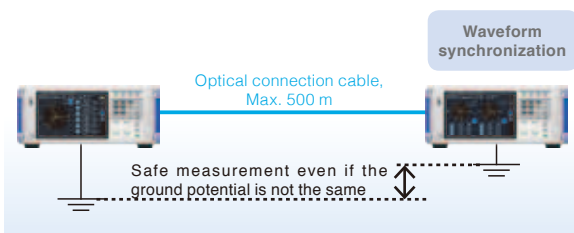

D/A output waveforms captured 500m away

Transfer voltage/current waveforms taken by the slave instrument located as far as 500m away and output the signals from the master device. When combined with a Hioki MEMORY HiCORDER, timing tests and simultaneous analysis of multiple channels for 3-phase power are possible.

Max. analog 32 channels + logic 32 channels
MEMORY HiCORDER MR8827

* The waveform that is output has a delay of 7 μs to 12 μs, depending on the distance.

Interface

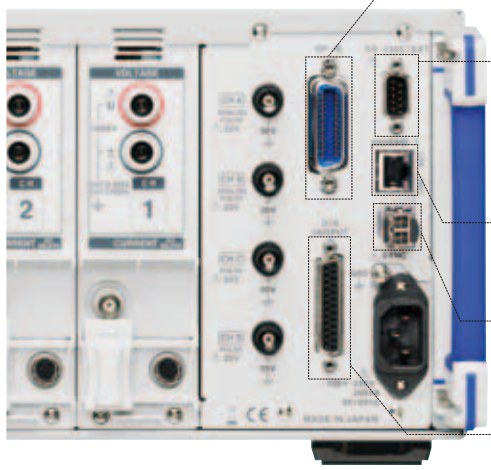

- GP-IB - View data in free dedicated application
- Command control*
- RS-232C - View data in free dedicated application
- Command control*
- External I/O - START/ STOP/ DATA RESET control
- Terminals shared with RS-232C, ±5 V/200 mA power supply possible
- LAN - Fast Gbit LAN supported, command control*
- View data in free dedicated application
- Synchronous control - Optical connection cable connector, Duplex-LC (2-core)
- D/A output (PW6001-11 to 16 only) - Switching for 20 channels of analog output or maximum 12 channels of waveform + 8 channels of analog output

* Download the Communications Command Instruction Manual from the Hioki website.

USB flash drive interface

- Save waveform data/measurement data (csv) and screen captures (bmp)
- Real-time save of interval data (csv) at a maximum speed of 10ms

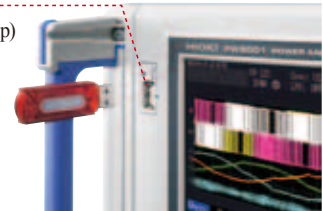

Internal memory

- Save interval data, for transfer later to USB flash drive

PC Communication Software – PW Communicator

(Available soon)

PW Communicator is an dedicated application software for communicating between a PW6001 power meter and a PC. Free download is available from the Hioki website. The application contains convenient functions for setting the PW6001, monitoring the measurement values, acquiring data via communication, computing efficiency, and much more.

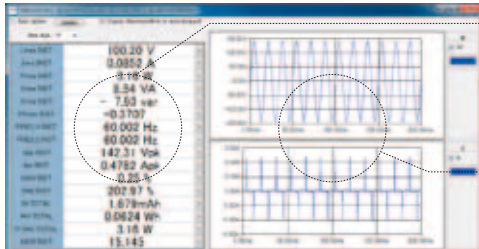

Value monitoring

Display the PW6001's measurement values on the PC screen. You can freely select up to 64 values, such as voltage, current, power, and harmonics.

Waveform monitoring

Monitor the voltage, current, and waveforms measured by the meter right on the PC screen.

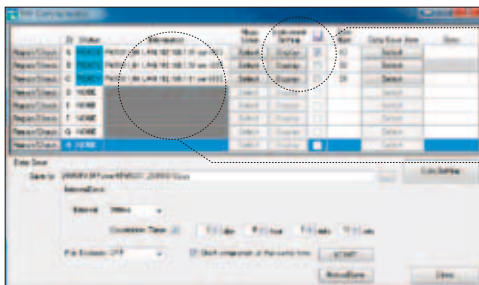

Meter setting

Configure the connected PW6001 from the PC screen.

Synchronous measurement

Compute the input/output efficiency of a power converter and similar operations when using multiple units of PW6001. In addition to the PW6001, you can also batch control other Hioki power meters, such as the PW3335, PW3336, and PW3337.

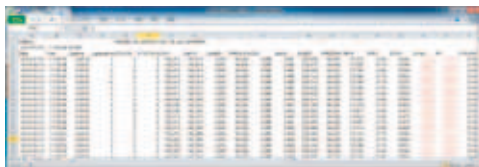

Saving data as CSV file

Record 180 or more measurement data to a CSV file at fixed intervals. The shortest interval between recordings is 200 ms.

PW Communicator Specifications

Availability	Free download from the Hioki website
Operating environment	PC/AT-compatible
OS	Windows 8, Windows 7 (32/64-bit)
Memory	2GB or more recommended
Interface	LAN, RS-232C, GP-IB

LabVIEW Driver (Available soon)

A LabVIEW driver compatible with the PW6001 will enable you to acquire data and build measurement systems. (LabVIEW is a registered trademark of National Instruments Corporation.)

Basic Specifications

Power measurement

Measurement lines	1-phase/2-wire (1P2W), 1-phase/3-wire (1P3W), 3-phase/3-wire (3P3W2M, 3V3A, 3P3W3M), 3-phase/4-wire (3P4W)					
	CH1	CH2	CH3	CH4	CH5	CH6
Pattern 1	1P2W	1P2W	1P2W	1P2W	1P2W	1P2W
Pattern 2	1P3W / 3P3W2M		1P2W	1P2W	1P2W	1P2W
Pattern 3	1P3W / 3P3W2M		1P2W	1P3W / 3P3W2M		1P2W
Pattern 4	1P3W / 3P3W2M		1P3W / 3P3W2M		1P3W / 3P3W2M	
Pattern 5	3P3W3M / 3V3A / 3P4W			1P2W	1P2W	1P2W
Pattern 6	3P3W3M / 3V3A / 3P4W			1P3W / 3P3W2M		1P2W
Pattern 7	3P3W3M / 3V3A / 3P4W			3P3W3M / 3V3A / 3P4W		
	For 2-channel combinations, select 1P3W or 3P3W2M. For 3-channel combinations, select 3P3W3M, 3V3A, or 3P4W.					
Number of channels	1	2	3	4	5	6
Pattern 1	✓	✓	✓	✓	✓	✓
Pattern 2	-	✓	✓	✓	✓	✓
Pattern 3	-	-	-	-	-	✓
Pattern 4	-	-	-	✓	-	✓
Pattern 5	-	-	✓	✓	✓	✓
Pattern 6	-	-	-	-	✓	✓
Pattern 7	-	-	-	-	-	✓
	Connection patterns that can be selected based on the number of channels: [✓] Can be selected, [-] Cannot be selected					
Number of input channels	Max. 6 channels; each input unit provides 1 channel for simultaneous voltage and current input					
Input terminal profile	Voltage Plug-in terminals (safety terminals) Probe 1 Dedicated connector (ME15W) Probe 2 BNC (metal) + power supply terminal					
Probe 2 power supply	+12 V ±0.5 V, -12 V ±0.5 V, max. 600 mA, up to a max. of 700 mA for up to 3 channels					
Input method	Voltage measurement unit Photoisolated input, resistance voltage divider Current measurement unit Isolated input from current sensor (voltage output)					
Voltage range	6 V / 15 V / 30 V / 60 V / 150 V / 300 V / 600 V / 1500 V					
Current range (Probe 1)	400 mA / 800 mA / 2 A / 4 A / 8 A / 20 A (with 20 A sensor) 4 A / 8 A / 20 A / 40 A / 80 A / 200 A (with 200 A sensor) 1 A / 2 A / 5 A / 10 A / 20 A / 50 A (with 50 A sensor) 10 A / 20 A / 50 A / 100 A / 200 A / 500 A (with 500 A sensor) 20 A / 40 A / 100 A / 200 A / 400 A / 1 kA (with CT6865)					
(Probe 2)	1 kA / 2 kA / 5 kA / 10 kA / 20 kA / 50 kA (with 0.1 mV/A sensor) 100 A / 200 A / 500 A / 1 kA / 2 kA / 5 kA (with 1 mV/A sensor) 10 A / 20 A / 50 A / 100 A / 200 A / 500 A (with 10 mV/A sensor; with 3274 or 3275) 1 A / 2 A / 5 A / 10 A / 20 A / 50 A (with 100 mV/A sensor; with 3273 or 3276) 100 mA / 200 mA / 500 mA / 1 A / 2 A / 5 A (with 1 V/A sensor; with CT6700 or CT6701) (0.1 V / 0.2 V / 0.5 V / 1.0 V / 2.0 V / 5.0 V range)					
Power range	2.40000 W to 4.50000 MW (depending on voltage and current combinations)					
Crest factor	3 (relative to voltage/current range rating); however, 1.33 for 1500 V range, 1.5 for 5 V Probe 2 range 300 (relative to minimum valid voltage and current input); however, 133 for 1500 V range, 150 for 5 V Probe 2 range					
Input resistance (50 Hz / 60 Hz)	Voltage inputs 4 MΩ ±40 kΩ Probe 1 inputs 1 MΩ ±50 kΩ Probe 2 inputs 1 MΩ ±50 kΩ					
Maximum input voltage	Voltage inputs 1000 V, ±2000 Vpeak (10 ms or less) Input voltage frequency of 250 kHz to 1 MHz, (1250 - f) V Input voltage frequency of 1 MHz to 5 MHz, 50 V Unit for f above: kHz Probe 1 inputs 5 V, ±12 Vpeak (10 ms or less) Probe 2 inputs 8 V, ±15 Vpeak (10 ms or less)					
Maximum rated voltage to earth	Voltage input terminal (50 Hz/60 Hz) CATIII 600V; anticipated transient overvoltage: 6000V CATIII 1000V; anticipated transient overvoltage: 6000V					
Measurement method	Voltage/current simultaneous digital sampling with zero-cross synchronized calculation					
Sampling	5 MHz / 18 bits					
Frequency band	DC, 0.1 Hz to 2 MHz					
Synchronization frequency range	0.1 Hz to 2 MHz					
Synchronization source	U1 to U6, I1 to I6, DC (fixed at data update rate), Ext1 to Ext2 The zero-cross point of the waveform after passing through the zero-cross filter is used as the standard for U or I selection.					
Data update rate	10 ms / 50 ms / 200 ms When using simple averaging, the data update rate varies based on the number of averaging iterations.					
LPF	500 Hz / 1 kHz / 5 kHz / 10 kHz / 50 kHz / 100 kHz / 500 kHz / OFF Approx. 500 kHz analog LPF + digital IIR filter (Butterworth characteristics equivalent) Except when off, add ±0.1% rdg. to the accuracy. Defined for frequencies that are less than or equal to 1/10 of the set frequency.					
Polarity detection voltage	Current zero-cross timing comparison					
Measurement parameters	Voltage (U), current (I), active power (P), apparent power (S), reactive power (Q), power factor (λ), phase angle (φ), frequency (f), efficiency (η), loss (Loss), voltage ripple factor (Urf), current ripple factor (Irf), current integration (Ih), power integration (WP), voltage peak (Upk), current peak (Ipk)					
Effective measurement range	Voltage, current, power: 1% to 110% of range					
Zero-suppression range	Select from OFF / 0.1% f.s. / 0.5% f.s. When set to OFF, a value may be displayed even when receiving zero input.					
Zero-adjustment	Zero-adjustment of input offsets that are less than ±10% f.s. for voltage and ±10% f.s. ±4 mV for current					

Accuracy	Sine wave input with a power factor of 1 or DC input, terminal-to-ground voltage of 0 V, after zero-adjustment Within the effective measurement range
----------	--

	Voltage (U)	Current (I)
DC	±0.02% rdg. ±0.03% f.s.	±0.02% rdg. ±0.03% f.s.
0.1 Hz ≤ f < 30 Hz	±0.1% rdg. ±0.2% f.s.	±0.1% rdg. ±0.2% f.s.
30 Hz ≤ f < 45 Hz	±0.03% rdg. ±0.05% f.s.	±0.03% rdg. ±0.05% f.s.
45 Hz ≤ f < 66 Hz	±0.02% rdg. ±0.02% f.s.	±0.02% rdg. ±0.02% f.s.
66 Hz < f ≤ 1 kHz	±0.03% rdg. ±0.04% f.s.	±0.03% rdg. ±0.04% f.s.
1 kHz < f ≤ 50 kHz	±0.1% rdg. ±0.05% f.s.	±0.1% rdg. ±0.05% f.s.
50 kHz < f ≤ 100 kHz	±0.01x% rdg. ±0.2% f.s.	±0.01x% rdg. ±0.2% f.s.
100 kHz < f ≤ 500 kHz	±0.008x% rdg. ±0.5% f.s.	±0.008x% rdg. ±0.5% f.s.
500 kHz < f ≤ 1 MHz	±(0.021x-7)% rdg. ±1% f.s.	±(0.021x-7)% rdg. ±1% f.s.
Frequency band	2 MHz (< 3 dB, typical)	2 MHz (< 3 dB, typical)

	Active power (P)	Phase difference
DC	±0.02% rdg. ±0.05% f.s.	-
0.1 Hz ≤ f < 30 Hz	±0.1% rdg. ±0.2% f.s.	±0.1°
30 Hz ≤ f < 45 Hz	±0.03% rdg. ±0.05% f.s.	±0.05°
45 Hz ≤ f < 66 Hz	±0.02% rdg. ±0.03% f.s.	±0.05°
66 Hz < f ≤ 1 kHz	±0.04% rdg. ±0.05% f.s.	±0.05°
1 kHz < f ≤ 10 kHz	±0.15% rdg. ±0.1% f.s.	±0.4°
10 kHz < f ≤ 50 kHz	±0.15% rdg. ±0.1% f.s.	±(0.040x)°
50 kHz < f ≤ 100 kHz	±0.012x% rdg. ±0.2% f.s.	±(0.050x)°
100 kHz < f ≤ 500 kHz	±0.009x% rdg. ±0.5% f.s.	±(0.055x)°
500 kHz < f ≤ 1 MHz	±(0.047x-19)% rdg. ±2% f.s.	±(0.055x)°

- Unit for f above: kHz
- Voltage and current DC values are defined for Udc and Idc, while frequencies other than DC are defined for Urms and Irms.
- When U or I is selected as the synchronization source, accuracy is defined for source input of at least 5% f.s.
- The phase difference is defined for a power factor of zero during f.s. input.
- Add the current sensor accuracy to the above accuracy figures for current, active power, and phase difference.
- For the 6 V range, add ±0.05% f.s. for voltage and active power.
- Add ±20 μV to the DC accuracy for current and active power when using Probe 1 (however, 2 V f.s.).
- Add ±0.05% rdg. ±0.2% f.s. for current and active power when using Probe 2, and add ±0.2° to the phase at or above 10 kHz.
- The accuracy figures for voltage, current, active power, and phase difference for 0.1 Hz to 10 Hz are reference values.
- The accuracy figures for voltage, active power, and phase difference in excess of 220 V from 10 Hz to 16 Hz are reference values.
- The accuracy figures for voltage, active power, and phase difference in excess of 750 V for values of f such that 30 kHz < f ≤ 100 kHz are reference values.
- The accuracy figures for voltage, active power, and phase difference in excess of (22000/f [kHz]) V for values of f such that 100 kHz < f ≤ 1 MHz are reference values.
- Add ±0.02% rdg. for voltage and active power at or above 1000 V (however, figures are reference values).
Even for input voltages that are less than 1000 V, the effect will persist until the input resistance temperature falls.
- For voltages in excess of 600 V, add the following to the phase difference accuracy:
- 500 Hz < f ≤ 5 kHz: ±0.3°
- 5 kHz < f ≤ 20 kHz: ±0.5°
- 20 Hz < f ≤ 200 kHz: ±1°

Measurement parameters	Accuracy
Apparent power	Voltage accuracy + current accuracy ±10 dgt.
Reactive power	Apparent power accuracy + $(\sqrt{2.69 \times 10^{-4} \times f + 1.0022 - \lambda^2} - \sqrt{1 - \lambda^2}) \times 100\% \text{ f.s.}$
Power factor	φ of other than ±90°: $\pm \left(1 - \frac{\cos(\phi + \text{phase difference accuracy})}{\cos(\phi)} \right) \times 100\% \text{ rdg.} \pm 50 \text{ dgt.}$ φ of ±90°: ±cos(φ + phase difference accuracy) × 100% f.s. ±50 dgt.
Waveform peak	Voltage/current RMS accuracy ±1% f.s. (f.s.: apply 300% of range)

f: kHz; φ: Display value for voltage/current phase difference; λ: Display value for power factor

Effects of temperature and humidity	Add the following to the voltage, current, and active power accuracy within the range of 0°C to 20°C or 28°C to 40°C: ±0.01% rdg./°C (add 0.01% f.s./°C for DC measured values) For current and active power when using Probe 2, ±0.02% rdg./°C (add 0.05% f.s./°C for DC measured values) Under conditions of 60% RH or greater: Add ±0.0006 × humidity [%RH] × f [kHz] rdg. to the voltage and active power accuracy. Add ±0.0006 × humidity [%RH] × f [kHz]° to the phase difference.
Effects of common-mode voltage	50 Hz/60 Hz 100 dB or greater (when applied between the voltage input terminals and the enclosure) 100 kHz 80 dB or greater (reference value) Defined for CMRR when the maximum input voltage is applied for all measurement ranges.
Effects of external magnetic fields	±1% f.s. or less (in a magnetic field of 400 A/m, DC or 50 Hz/60 Hz)
Effects of power factor	φ of other than ±90°: $\pm \left(1 - \frac{\cos(\phi + \text{phase difference accuracy})}{\cos(\phi)} \right) \times 100\% \text{ rdg.}$ φ of ±90°: ±cos(φ + phase difference accuracy) × 100% f.s.

Frequency measurement

Number of measurement channels	Max. 6 channels (f1 to f6), based on the number of input channels
Measurement source	Select from U/I for each connection.
Measurement method	Reciprocal method + zero-cross sampling value correction Calculated from the zero-cross point of waveforms after application of the zero-cross filter.
Measurement range	0.1 Hz to 2 MHz (Display shows 0.00000 Hz or ----- Hz if measurement is not possible.)
Accuracy	±0.05% rdg. ±1 dgt. (with a sine wave that is at least 30% of the measurement source's measurement range)
Display format	0.100000 Hz to 9.999999 Hz, 9.90000 Hz to 99.9999 Hz, 99.0000 Hz to 999.999 Hz, 0.990000 kHz to 9.990000 kHz, 9.900000 kHz to 99.99999 kHz, 99.00000 kHz to 999.999 kHz, 0.990000 MHz to 2.00000 MHz

Integration measurement

Measurement modes	Select RMS or DC for each connection (DC mode can only be selected when using an AC/DC sensor with a 1P2W connection).
Measurement parameters	Current integration (Ih+, Ih-, Ih), active power integration (WP+, WP-, WP) Ih+ and Ih- are measured only in DC mode. Only Ih is measured in RMS mode.
Measurement method	Digital calculation based on current and active power values DC mode Every sampling interval, current values and instantaneous power values are integrated separately for each polarity. RMS mode The current RMS value and active power value are integrated for each measurement interval. Only active power is integrated separately for each polarity.
Display resolution	999999 (6 digits + decimal point), starting from the resolution at which 1% of each range is f.s.
Measurement range	0 to ±9999.99 TAh/TWh
Integration time	10 sec. to 9999 hr. 59 min. 59 sec.
Integration time accuracy	±0.02% rdg. (0°C to 40°C)
Integration accuracy	±(current or active power accuracy) ±integration time accuracy
Backup function	None

Harmonics measurement

Number of measurement channels	Max. 6 channels, based on the number of built-in channels
Synchronization source	Based on the synchronization source setting for each connection.
Measurement modes	Select from IEC standard mode or wideband mode (setting applies to all channels).
Measurement parameters	Harmonic voltage RMS value, harmonic voltage content percentage, harmonic voltage phase angle, harmonic current RMS value, harmonic current content percentage, harmonic current phase angle, harmonic active power, harmonic power content percentage, harmonic voltage/current phase difference, total harmonic voltage distortion, total harmonic current distortion, voltage unbalance rate, current unbalance rate (no intermediate harmonic parameters in IEC standard mode)
FFT processing word length	32 bits
Antialiasing	Digital filter (automatically configured based on synchronization frequency)
Window function	Rectangular
Grouping	OFF / Type 1 (harmonic sub-group) / Type 2 (harmonic group)
THD calculation method	THD_F / THD_R (Setting applies to all connections.) Select calculation order from 2nd order to 100th order (however, limited to the maximum analysis order for each mode).

(1) IEC standard mode

Measurement method	Zero-cross synchronization calculation method (same window for each synchronization source) Fixed sampling interpolation calculation method with average thinning in window IEC 61000-4-7:2002 compliant with gap overlap																														
Synchronization frequency range	45 Hz to 66 Hz																														
Data update rate	Fixed at 200 ms.																														
Analysis orders	0th to 50th																														
Window wave number	When less than 56 Hz, 10 waves; when 56 Hz or greater, 12 waves																														
Number of FFT points	4096 points																														
Accuracy	<table border="1"> <thead> <tr> <th>Frequency</th> <th>Harmonic voltage and current</th> <th>Harmonic power</th> <th>Phase difference</th> </tr> </thead> <tbody> <tr> <td>DC (0th order)</td> <td>±0.1% rdg. ±0.1% f.s.</td> <td>±0.1% rdg. ±0.2% f.s.</td> <td>--</td> </tr> <tr> <td>45 Hz ≤ f ≤ 66 Hz</td> <td>±0.2% rdg. ±0.04% f.s.</td> <td>±0.4% rdg. ±0.05% f.s.</td> <td>±0.08°</td> </tr> <tr> <td>66 Hz < f ≤ 440 Hz</td> <td>±0.5% rdg. ±0.05% f.s.</td> <td>±1.0% rdg. ±0.05% f.s.</td> <td>±0.08°</td> </tr> <tr> <td>440 Hz < f ≤ 1 kHz</td> <td>±0.8% rdg. ±0.05% f.s.</td> <td>±1.5% rdg. ±0.05% f.s.</td> <td>±0.4°</td> </tr> <tr> <td>1 kHz < f ≤ 2.5 kHz</td> <td>±2.4% rdg. ±0.05% f.s.</td> <td>±4% rdg. ±0.05% f.s.</td> <td>±0.4°</td> </tr> <tr> <td>2.5 kHz < f ≤ 3.3 kHz</td> <td>±6% rdg. ±0.05% f.s.</td> <td>±10% rdg. ±0.05% f.s.</td> <td>±0.8°</td> </tr> </tbody> </table> <p>Power is defined for a power factor of 1. Accuracy specifications are defined for fundamental wave input that is greater than or equal to 50% of the range. Add the current sensor accuracy to the above accuracy figures for current, active power, and phase difference. Add ±0.02% rdg. for voltage and active power at or above 1000 V (however, figures are reference values). Even for input voltages that are less than 1000 V, the effect will persist until the input resistance temperature falls.</p>			Frequency	Harmonic voltage and current	Harmonic power	Phase difference	DC (0th order)	±0.1% rdg. ±0.1% f.s.	±0.1% rdg. ±0.2% f.s.	--	45 Hz ≤ f ≤ 66 Hz	±0.2% rdg. ±0.04% f.s.	±0.4% rdg. ±0.05% f.s.	±0.08°	66 Hz < f ≤ 440 Hz	±0.5% rdg. ±0.05% f.s.	±1.0% rdg. ±0.05% f.s.	±0.08°	440 Hz < f ≤ 1 kHz	±0.8% rdg. ±0.05% f.s.	±1.5% rdg. ±0.05% f.s.	±0.4°	1 kHz < f ≤ 2.5 kHz	±2.4% rdg. ±0.05% f.s.	±4% rdg. ±0.05% f.s.	±0.4°	2.5 kHz < f ≤ 3.3 kHz	±6% rdg. ±0.05% f.s.	±10% rdg. ±0.05% f.s.	±0.8°
Frequency	Harmonic voltage and current	Harmonic power	Phase difference																												
DC (0th order)	±0.1% rdg. ±0.1% f.s.	±0.1% rdg. ±0.2% f.s.	--																												
45 Hz ≤ f ≤ 66 Hz	±0.2% rdg. ±0.04% f.s.	±0.4% rdg. ±0.05% f.s.	±0.08°																												
66 Hz < f ≤ 440 Hz	±0.5% rdg. ±0.05% f.s.	±1.0% rdg. ±0.05% f.s.	±0.08°																												
440 Hz < f ≤ 1 kHz	±0.8% rdg. ±0.05% f.s.	±1.5% rdg. ±0.05% f.s.	±0.4°																												
1 kHz < f ≤ 2.5 kHz	±2.4% rdg. ±0.05% f.s.	±4% rdg. ±0.05% f.s.	±0.4°																												
2.5 kHz < f ≤ 3.3 kHz	±6% rdg. ±0.05% f.s.	±10% rdg. ±0.05% f.s.	±0.8°																												

(2) Wideband mode

Measurement method	Zero-cross synchronization calculation method (same window for each synchronization source) with gaps Fixed sampling interpolation calculation method																																														
Synchronization frequency range	0.1 Hz to 300 kHz																																														
Data update rate	Fixed at 50 ms.																																														
Maximum analysis order and Window wave number	<table border="1"> <thead> <tr> <th>Frequency</th> <th>Window wave number</th> <th>Maximum analysis order</th> </tr> </thead> <tbody> <tr><td>0.1 Hz ≤ f < 80 Hz</td><td>1</td><td>100th</td></tr> <tr><td>80 Hz ≤ f < 160 Hz</td><td>2</td><td>100th</td></tr> <tr><td>160 Hz ≤ f < 320 Hz</td><td>4</td><td>60th</td></tr> <tr><td>320 Hz ≤ f < 640 Hz</td><td>2</td><td>60th</td></tr> <tr><td>640 Hz ≤ f < 6 kHz</td><td>4</td><td>50th</td></tr> <tr><td>6 kHz ≤ f < 12 kHz</td><td>2</td><td>50th</td></tr> <tr><td>12 kHz ≤ f < 25 kHz</td><td>4</td><td>50th</td></tr> <tr><td>25 kHz ≤ f < 50 kHz</td><td>8</td><td>30th</td></tr> <tr><td>50 kHz ≤ f < 101 kHz</td><td>16</td><td>15th</td></tr> <tr><td>101 kHz ≤ f < 201 kHz</td><td>32</td><td>7th</td></tr> <tr><td>201 kHz ≤ f < 300 kHz</td><td>64</td><td>5th</td></tr> </tbody> </table>	Frequency	Window wave number	Maximum analysis order	0.1 Hz ≤ f < 80 Hz	1	100th	80 Hz ≤ f < 160 Hz	2	100th	160 Hz ≤ f < 320 Hz	4	60th	320 Hz ≤ f < 640 Hz	2	60th	640 Hz ≤ f < 6 kHz	4	50th	6 kHz ≤ f < 12 kHz	2	50th	12 kHz ≤ f < 25 kHz	4	50th	25 kHz ≤ f < 50 kHz	8	30th	50 kHz ≤ f < 101 kHz	16	15th	101 kHz ≤ f < 201 kHz	32	7th	201 kHz ≤ f < 300 kHz	64	5th										
Frequency	Window wave number	Maximum analysis order																																													
0.1 Hz ≤ f < 80 Hz	1	100th																																													
80 Hz ≤ f < 160 Hz	2	100th																																													
160 Hz ≤ f < 320 Hz	4	60th																																													
320 Hz ≤ f < 640 Hz	2	60th																																													
640 Hz ≤ f < 6 kHz	4	50th																																													
6 kHz ≤ f < 12 kHz	2	50th																																													
12 kHz ≤ f < 25 kHz	4	50th																																													
25 kHz ≤ f < 50 kHz	8	30th																																													
50 kHz ≤ f < 101 kHz	16	15th																																													
101 kHz ≤ f < 201 kHz	32	7th																																													
201 kHz ≤ f < 300 kHz	64	5th																																													
Phase zero-adjustment	The instrument provides phase zero-adjustment functionality using keys or communications commands (only available when the synchronization source is set to Ext).																																														
Accuracy	Add the following to the accuracy figures for voltage (U), current (I), active power (P), and phase difference. (Unit for f in following table: kHz)																																														
	<table border="1"> <thead> <tr> <th>Frequency</th> <th>Harmonic voltage and current</th> <th>Harmonic power</th> <th>Phase difference</th> </tr> </thead> <tbody> <tr><td>DC</td><td>±0.1% f.s.</td><td>±0.2% f.s.</td><td>-</td></tr> <tr><td>0.1 Hz ≤ f < 30 Hz</td><td>±0.05% f.s.</td><td>±0.05% f.s.</td><td>±0.1°</td></tr> <tr><td>30 Hz ≤ f < 45 Hz</td><td>±0.1% f.s.</td><td>±0.2% f.s.</td><td>±0.1°</td></tr> <tr><td>45 Hz ≤ f ≤ 66 Hz</td><td>±0.05% f.s.</td><td>±0.1% f.s.</td><td>±0.1°</td></tr> <tr><td>66 Hz < f ≤ 1 kHz</td><td>±0.05% f.s.</td><td>±0.1% f.s.</td><td>±0.1°</td></tr> <tr><td>1 kHz < f ≤ 10 kHz</td><td>±0.05% f.s.</td><td>±0.1% f.s.</td><td>±0.6°</td></tr> <tr><td>10 kHz < f ≤ 50 kHz</td><td>±0.2% f.s.</td><td>±0.4% f.s.</td><td>±(0.020xf)° ±0.5°</td></tr> <tr><td>50 kHz < f ≤ 100 kHz</td><td>±0.4% f.s.</td><td>±0.5% f.s.</td><td>±(0.020xf)° ±1°</td></tr> <tr><td>100 kHz < f ≤ 500 kHz</td><td>±1% f.s.</td><td>±2% f.s.</td><td>±(0.030xf)° ±1.5°</td></tr> <tr><td>500 kHz < f ≤ 900 kHz</td><td>±4% f.s.</td><td>±5% f.s.</td><td>±(0.030xf)° ±2°</td></tr> </tbody> </table> <p>The figures for voltage, current, power, and phase difference for frequencies in excess of 300 kHz are reference values. When the fundamental wave is outside the range of 16 Hz to 850 Hz, the figures for voltage, current, power, and phase difference for frequencies other than the fundamental wave are reference values. When the fundamental wave is within the range of 16 Hz to 850 Hz, the figures for voltage, current, power, and phase difference in excess of 6 kHz are reference values. Accuracy values for phase difference are defined for input for which the voltage and current for the same order are at least 10% f.s.</p>	Frequency	Harmonic voltage and current	Harmonic power	Phase difference	DC	±0.1% f.s.	±0.2% f.s.	-	0.1 Hz ≤ f < 30 Hz	±0.05% f.s.	±0.05% f.s.	±0.1°	30 Hz ≤ f < 45 Hz	±0.1% f.s.	±0.2% f.s.	±0.1°	45 Hz ≤ f ≤ 66 Hz	±0.05% f.s.	±0.1% f.s.	±0.1°	66 Hz < f ≤ 1 kHz	±0.05% f.s.	±0.1% f.s.	±0.1°	1 kHz < f ≤ 10 kHz	±0.05% f.s.	±0.1% f.s.	±0.6°	10 kHz < f ≤ 50 kHz	±0.2% f.s.	±0.4% f.s.	±(0.020xf)° ±0.5°	50 kHz < f ≤ 100 kHz	±0.4% f.s.	±0.5% f.s.	±(0.020xf)° ±1°	100 kHz < f ≤ 500 kHz	±1% f.s.	±2% f.s.	±(0.030xf)° ±1.5°	500 kHz < f ≤ 900 kHz	±4% f.s.	±5% f.s.	±(0.030xf)° ±2°		
Frequency	Harmonic voltage and current	Harmonic power	Phase difference																																												
DC	±0.1% f.s.	±0.2% f.s.	-																																												
0.1 Hz ≤ f < 30 Hz	±0.05% f.s.	±0.05% f.s.	±0.1°																																												
30 Hz ≤ f < 45 Hz	±0.1% f.s.	±0.2% f.s.	±0.1°																																												
45 Hz ≤ f ≤ 66 Hz	±0.05% f.s.	±0.1% f.s.	±0.1°																																												
66 Hz < f ≤ 1 kHz	±0.05% f.s.	±0.1% f.s.	±0.1°																																												
1 kHz < f ≤ 10 kHz	±0.05% f.s.	±0.1% f.s.	±0.6°																																												
10 kHz < f ≤ 50 kHz	±0.2% f.s.	±0.4% f.s.	±(0.020xf)° ±0.5°																																												
50 kHz < f ≤ 100 kHz	±0.4% f.s.	±0.5% f.s.	±(0.020xf)° ±1°																																												
100 kHz < f ≤ 500 kHz	±1% f.s.	±2% f.s.	±(0.030xf)° ±1.5°																																												
500 kHz < f ≤ 900 kHz	±4% f.s.	±5% f.s.	±(0.030xf)° ±2°																																												

Waveform recording

Number of measurement channels	Voltage and current waveforms Motor waveforms *	Max. 6 channels (based on the number of installed channels) Max. 2 analog DC channels + max. 4 pulse channels
Recording capacity	1 Mword × (voltage + current) × number of channels + motor waveforms *	
Waveform resolution	16 bits (Voltage and current waveforms use the upper 16 bits of the 18-bit A/D.)	
Sampling speed	Voltage and current waveforms Motor waveforms * Motor pulse *	Always 5 MS/s Always 50 kS/s Always 5 MS/s
Compression ratio	1/1, 1/2, 1/5, 1/10, 1/20, 1/50, 1/100, 1/200, 1/500 (5 MS/s, 2.5 MS/s, 1 MS/s, 500 kS/s, 250 kS/s, 100 kS/s, 50 kS/s, 25 kS/s, 10 kS/s) However, motor waveforms* are only compressed at 50 kS/s or less.	
Recording length	1 kWord / 5 kWord / 10 kWord / 50 kWord / 100 kWord / 500 kWord / 1 Mword	
Storage mode	Peak-to-peak compression or simple thinning	

Trigger mode	SINGLE or NORMAL (with forcible trigger setting)
Pre-trigger	0% to 100% of the recording length, in 10% steps
Trigger source	Voltage and current waveform, waveform after voltage and current zero-cross filter, manual, motor waveform*, motor pulse*
Trigger slope	Rising edge, falling edge
Trigger level	±300% of the range for the waveform, in 0.1% steps

*Motor waveform and motor pulse: Motor analysis and D/A-equipped models only

Motor analysis (PW6001-I1 to -I6 only)

Number of input channels	4 channels CH A Analog DC input / Frequency input / Pulse input CH B Analog DC input / Frequency input / Pulse input CH C Pulse input CH D Pulse input
Operating mode	Single, dual, or independent input
Input terminal profile	Isolated BNC connectors
Input resistance (DC)	1 MΩ ±50 kΩ
Input method	Function-isolated input and single-end input
Measurement parameters	Voltage, torque, rpm, frequency, slip, motor power
Maximum input voltage	±20 V (analog DC and pulse operation)
Additional conditions for guaranteed accuracy	Input: Terminal-to-ground voltage of 0 V, after zero-adjustment

(1) Analog DC input (CH A/CH B)

Measurement range	±1 V / ±5 V / ±10 V
Effective input range	1% to 110% f.s.
Sampling	50 kHz, 16 bits
Response speed	0.2 ms (when LPF is OFF)
Measurement method	Simultaneous digital sampling, zero-cross synchronization calculation method (averaging between zero-crosses)
Measurement accuracy	±0.05% rdg. ±0.05% f.s.
Temperature coefficient	±0.03% f.s./°C
Effects of common-mode voltage	±0.01% f.s. or less with 50 V applied between the input terminals and the enclosure (DC / 50 Hz / 60 Hz)
LPF	OFF (20 kHz) / ON (1 kHz)
Display range	From the range's zero-suppression range setting to ±150%
Zero-adjustment	Voltage ±10% f.s., zero-correction of input offsets that are less

(2) Frequency input (CH A/CH B)

Detection level	Low: 0.5 V or less; high: 2.0 V or more
Measurement frequency band	0.1 Hz to 1 MHz (at 50% duty ratio)
Minimum detection width	0.5 μs or more
Measurement accuracy	±0.05% rdg. ±3 dgt.
Display range	1.000 kHz to 500.000 kHz

(3) Pulse input (CH A / CH B / CH C / CH D)

Detection level	Low: 0.5 V or less; high: 2.0 V or more
Measurement frequency band	0.1 Hz to 1 MHz (at 50% duty ratio)
Minimum detection width	0.5 μs or more
Pulse filter	OFF / Weak / Strong (When using the weak setting, positive and negative pulses of less than 0.5 μs are ignored. When using the strong setting, positive and negative pulses of 5 μs are ignored.)
Measurement accuracy	±0.05% rdg. ±3 dgt.
Display range	0.1 Hz to 800.000 kHz
Unit	Hz / r/min.
Frequency division setting range	1~60000
Rotation direction detection	Can be set in single mode (detected based on lead/lag of CH B and CH C).
Mechanical angle origin detection	Can be set in single mode (CH B frequency division cleared at CH D rising edge).

D/A output (PW6001-I1 to -I6 only)

Number of output channels	20 channels	
Output terminal profile	D-sub 25-pin connector x 1	
Output details	- Switchable between waveform output and analog output (select from basic measurement parameters) - Waveform output is fixed to CH1 to CH12.	
D/A conversion resolution	16 bits (polarity + 15 bits)	
Output refresh rate	Analog output Waveform output	10 ms / 50 ms / 200 ms (based on data update rate for the selected parameter) 1 MHz
Output voltage	Analog output Waveform output	±5 V DC f.s. (max. approx. ±12 V DC) Switchable between ±2 V f.s. and ±1 V f.s., crest factor of 2.5 or greater Setting applies to all channels.
Output resistance	100 Ω ±5 Ω	
Output accuracy	Analog output Waveform output	Output measurement parameter measurement accuracy ±0.2% f.s. (DC level) Measurement accuracy ±0.5% f.s. (at ±2 V f.s.) or ±1.0% f.s. (at ±1 V f.s.) (RMS value level, up to 50 kHz)
Temperature coefficient	±0.05% f.s./°C	

Display section

Display characters	English / Japanese / Chinese (simplified, available soon)	
Display	9" WVGA TFT color LCD (800 × 480 dots) with an LED backlight and analog resistive touch panel	
Display value resolution	999999 count (including integration values)	
Display refresh rate	Measured values Waveforms	Approx. 200 ms (independent of internal data update rate) When using simple averaging, the data update rate varies based on the number of averaging iterations. Based on display settings

External interface

(1) USB flash drive interface

Connector	USB Type A connector x 1
Electrical specifications	USB 2.0 (high-speed)
Power supplied	Max. 500 mA
Supported USB flash drives	USB Mass Storage Class compatible
Recorded data	- Save/load settings files - Save measured values/automatic recorded data (CSV format) - Copy measured values/recorded data (from internal memory) - Save waveform data, save screenshots (compressed BMP format)

(2) LAN interface

Connector	RJ-45 connector x 1
Electrical specifications	IEEE 802.3 compliant
Transmission method	10Base-T / 100Base-TX / 1000Base-T (automatic detection)
Protocol	TCP/IP (with DHCP function)
Functions	dedicated port (data transfers, command control)

(3) GP-IB interface

Communication method	IEEE 488.1 1987 compliant developed with reference to IEEE 488.2 1987 Interface functions: SH1, AH1, T6, L4, SR1, RL1, PP0, DC1, DT1, C0
Addresses	00 to 30
Functions	Command control

(4) RS-232C interface

Connector	D-sub 9-pin connector x 1, 9-pin power supply compatible, also used for external control
Communication method	RS-232C, EIA RS-232D, CCITT V.24, and JIS X5101 compliant
Flow control	Hardware flow control ON/OFF
Communications speed	9,600 bps / 19,200 bps / 38,400 bps / 57,600 bps / 115,200 bps / 230,400 bps
Functions	Command control Used through exclusive switching with external control interface

(5) External control interface

Connector	D-sub 9-pin connector x 1, 9-pin power supply compatible, also used for RS-232C
Power supplied	OFF/ON (voltage of +5 V, max. 200 mA)
Electrical specifications	0/5 V (2.5 V to 5 V) logic signals or contact signal with terminal shorted or open
Functions	Same operation as the [START/STOP] key or the [DATA RESET] key on the control panel Used through exclusive switching with RS-232C

(6) Two-instrument synchronization interface

Connector	SFP optical transceiver, Duplex-LC (2-wire LC)
Optical signal	850 nm VCSEL, 1 Gbps
Laser class	Class 1
Fiber used	50/125 μ m multi-mode fiber equivalent, up to 500 m
Functions	Sends data from the connected slave instrument to the master instrument, which performs calculations and displays the results.

Functional Specifications

Auto-range function

Functions	The voltage and current ranges for each connection are automatically changed in response to the input.
Operating mode	OFF/ON (selectable for each connection)
Auto-range breadth	Broad/narrow (applies to all channels) Broad The range is increased by one if the peak value is exceeded for the connection or if there is an RMS value that is greater than or equal to 110% f.s. The range is lowered by two if all RMS values for the connection are less than or equal to 10% f.s. (However, the range is not lowered if the peak value would be exceeded with the lower range.) Narrow The range is increased by one if the peak value is exceeded for the connection or if there is an RMS value that is greater than or equal to 105% f.s. The range is lowered by one if all RMS values for the connection are less than or equal to 40% f.s. (However, the range is not lowered if the peak value would be exceeded with the lower range.) When Δ -Y conversion is enabled, the range reduction is determined by multiplying the range by $\frac{1}{\sqrt{3}}$.

Time control function

Timer control	OFF, 10 sec. to 9999 hr. 59 min. 59 sec. (in 1 sec. steps)
Actual time control	OFF, start time/stop time (in 1 min. steps)
Intervals	OFF / 10 ms / 50 ms / 200 ms / 500 ms / 1 sec. / 5 sec. / 10 sec. / 15 sec. / 30 sec. / 1 min. / 5 min. / 10 min. / 15 min. / 30 min. / 60 min.

Hold functionality

Hold	Stops updating the display with all measured values and holds the value currently being displayed. Used exclusively with the peak hold function.
Peak hold	Updates the measured value display each time a new maximum value is set. Used exclusively with the hold function.

Calculation functionality

(1) Rectifier

Functions	Selects the voltage and current values used to calculate apparent and reactive power and power factor.
Operating mode	RMS/mean (Can be selected for each connection's voltage and current.)

(2) Scaling

VT (PT) ratio	OFF/ 0.01 to 9999.99
CT ratio	OFF/ 0.01 to 9999.99

(3) Averaging (AVG)

Functions	All instantaneous measured values, including harmonics, are averaged.					
Operating mode	OFF / Simple averaging / Exponential averaging					
Operation	Simple averaging	Averaging is performed for the number of simple averaging iterations for each data update cycle, and the output data is updated. The data update rate is lengthened by the number of averaging iterations.				
	Exponential averaging	Data is exponentially averaged using a time constant defined by the data update rate and the exponential averaging response rate. During averaging operation, averaged data is used for all analog output and save data.				
Number of simple averaging iterations	Number of averaging iterations	5	10	20	50	100
	Data update rate	10 ms 50 ms 200 ms	50 ms 250 ms 1 sec.	100 ms 500 ms 2 sec.	200 ms 1 sec. 4 sec.	500 ms 2.5 sec. 10 sec.
Exponential averaging response rate	Setting	FAST	MID	SLOW		
	Data update rate	10 ms 50 ms 200 ms	0.1 sec. 0.5 sec. 2.0 sec.	0.8 sec. 4 sec. 16 sec.	5 sec. 25 sec. 100 sec.	

These values indicate the time required for the final stabilized value to converge on $\pm 1\%$ when the input changes from 0% f.s. to 90% f.s.

(4) Efficiency and loss calculations

Calculated items	Active power value (P), fundamental wave active power (P _{fnd}), and motor power (P _m) (Motor analysis and D/A-equipped models only) for each channel and connection
Number of calculations that can be performed	Four each for efficiency and loss
Formula	Calculated items are specified for Pin(n) and Pout(n) in the following format: Pin = Pin1 + Pin2 + Pin3 + Pin4, Pout = Pout1 + Pout2 + Pout3 + Pout4 $\eta = 100 \times \frac{P_{out}}{P_{in}}$, Loss = $P_{in} - P_{out}$

(5) Power formula selection

Functions	Selects the reactive power, power factor, and power phase angle formulas.
Formula	TYPE1 / TYPE2 / TYPE3 TYPE1 Compatible with TYPE1 as used by the Hioki 3193 and 3390. TYPE2 Compatible with TYPE2 as used by the Hioki 3192 and 3193. TYPE3 The sign of the TYPE1 power factor and power phase angle are used as the active power signs.

(6) Delta conversion

Functions	Δ -Y	When using a 3P3W3M or 3V3A connection, converts the line voltage waveform to a phase voltage waveform using a virtual neutral point.
	Y- Δ	When using a 3P4W connection, converts the phase voltage waveform to a line voltage waveform.
Voltage RMS values and all voltage parameters, including harmonics, are calculated using the post-conversion voltage.		

(7) Current sensor phase shift calculation

Functions	Corrects the current sensor's harmonic phase characteristics using calculations.
Correction value settings	Correction points are set using the frequency and phase difference.
	Frequency 0.1 kHz to 999.9 kHz (in 0.1 kHz steps)
	Phase difference 0.0 deg. to ± 90.0 deg. (in 0.1 deg. steps)
However, the time difference calculated from the frequency's phase difference is subject to a maximum value of 50 μ s.	

Display functionality

(1) Connection confirmation screen

Functions	Displays a connection diagram and voltage and current vectors based on the selected measurement lines. The ranges for a correct connection are displayed on the vector display so that the connection can be checked.
Mode at startup	User can select to display the connection confirmation screen at startup (startup screen setting).
Simple settings	Commercial power supply / Commercial power supply high-resolution HD / DC / DC high-resolution HD / PWM / High-frequency / Other

(2) Vector display screen

Functions	Displays a connection-specific vector graph along with associated level values and phase angles.
-----------	--

(3) Numerical display screen

Functions	Displays power measured values and motor measured values for up to six instrument channels.	
Display patterns	Basic by connection	Displays measured values for the measurement lines and motors combined in the connection. There are four measurement line patterns: U, I, P, and Integ.
	Selection display	Creates a numerical display for the measurement parameters that the user has selected from all basic measurement parameters in the location selected by the user. There are 4-, 8-, 16-, and 32-display patterns.

(4) Harmonic display screen

Functions	Displays harmonic measured values on the instrument's screen.	
Display patterns	Display bar graph	Displays harmonic measurement parameters for user-specified channels as a bar graph.
	Display list	Displays numerical values for user-specified parameters and user-specified channels.

(5) Waveform display screen

Functions	Displays the voltage and current waveforms and motor waveform.	
Display patterns	All-waveform display, waveform + numerical display	

Automatic save function

Functions	Saves the specified measured values in effect for each interval.	
Save destination	OFF / Internal memory / USB flash drive	
Saved parameters	User-selected from all measured values, including harmonic measured values	
Maximum amount of saved data	Internal memory	64 MB (data for approx. 1800 measurements)
	USB flash drive	Approx. 100 MB per file (automatically segmented) x 20 files
Data format	CSV file format	

Manual save function

(1) Measurement data

Functions	The [SAVE] key saves specified measured values at the time it is pressed. Comment text can be entered for each saved data point, up to a maximum of 20 alphanumeric characters. * The manual save function for measurement data cannot be used while automatic save is in progress.
Save destination	USB flash drive
Saved parameters	User-selected from all measured values, including harmonic measured values
Data format	CSV file format

(2) Waveform data

Functions	A button on the touch screen saves waveform data at the time it is pressed. Comment text can be entered for each saved data point, up to a maximum of 40 alphanumeric characters. * The manual save function for measurement data cannot be used while automatic saving is in progress.
Save destination	USB flash drive
Data format	CSV file format

(3) Screenshots

Functions	The [COPY] key saves a screenshot to the save destination. * This function can be used at an interval of 1 sec or more while automatic saving is in progress.
Save destination	USB flash drive
Comment entry	OFF / Text / Handwritten When set to [Text], up to 40 alphanumeric characters When set to [Handwritten], hand-drawn images are pasted to the screen.
Data format	Compressed BMP

(4) Settings data

Functions	Saves settings information to the save destination as a settings file via functionality provided on the File screen. In addition, previously saved settings files can be loaded and their settings restored on the File screen. However, language and communications settings are not saved.
Save destination	USB flash drive

Two-instrument synchronization function

Functions	Sends data from the connected slave instrument to the master instrument, which performs calculations and displays the results. In numerical synchronization mode, the master instrument operates as a power meter with up to 12 channels. In waveform synchronization mode, the master instrument operates while synchronizing up to three channels from the slave instrument at the waveform level.	
Operating mode	OFF / Numerical synchronization / Waveform synchronization Numerical synchronization cannot be selected when the data update rate is 10 ms. For both master instruments and slave instruments, waveform synchronization operates only when there are 3 or more channels.	
Synchronized items	Numerical synchronization mode Waveform synchronization mode	Data update timing, start/stop/data reset Voltage/current sampling timing
Synchronization delay	Numerical synchronization mode Waveform synchronization mode	Max. 20 μs Up to 5 samples
Transfer items	Numerical synchronization mode Waveform synchronization mode	Basic measurement parameters for up to six channels (including motor data) Voltage/current sampling waveforms for up to three channels (not including motor data). However, the maximum number of channels is limited to a total of six, including the master instrument's channels.

Other functions

Clock function	Auto-calendar, automatic leap year detection, 24-hour clock
Actual time accuracy	When the instrument is on, ±100 ppm; when the instrument is off, within ±3 sec./day (25°C)
Sensor identification	Current sensors connected to Probe1 are automatically detected.
Zero-adjustment function	After the AC/DC current sensor's DEMAG signal is sent, zero-correction of the voltage and current input offsets is performed.
Touch screen correction	Position calibration is performed for the touch screen.
Key lock	While the key lock is engaged, the key lock icon is displayed on the screen.

General Specifications

Operating environment	Indoors at an elevation of up to 2000 m in a Pollution Level 2 environment
Storage temperature and humidity	-10°C to 50°C, 80% RH or less (no condensation)
Operating temperature and humidity	0°C to 40°C, 80% RH or less (no condensation)
Dielectric strength	50 Hz/60 Hz 5.4 kVrms AC for 1 min. (sensed current of 1 mA) Between voltage input terminals and instrument enclosure, and between current sensor input terminals and interfaces 1 kVrms AC for 1 min. (sensed current of 3 mA) Between motor input terminals (Ch. A, Ch. B, Ch. C, and Ch. D) and the instrument enclosure
Standards	Safety EN61010 EMC EN61326 Class A, EN61000-3-2, EN61000-3-3
Rated supply voltage	100 V AC to 240 V AC, 50 Hz/ 60 Hz
Maximum rated power	200 VA
External dimensions	Approx. 430 (W) × 177 (H) × 450 (D) mm (excluding protruding parts)
Mass	Approx. 14 kg ±0.5 kg (PW6001-16)
Backup battery life	Approx. 10 years (reference value at 23°C) (lithium battery that stores time and setting conditions)
Product warranty period	1 year
Guaranteed accuracy period	6 months (1-year accuracy = 6-month accuracy × 1.5)
Post-adjustment accuracy guaranteed period	6 months
Accuracy guarantee conditions	Accuracy guarantee temperature and humidity range: 23°C ±3°C, 80% RH or less Warm-up time: 30 min. or more
Accessories	Instruction manual × 1, power cord × 1, D-sub 25-pin connector × 1 (PW6001-1x only)

Formulae

Basic formula





Wiring	1P2W	1P3W	3P3W2M	3V3A	3P3W3M	3P4W
Parameter						
Voltage, current RMS value (actual RMS value)	$X_{rms(i)} = \sqrt{\frac{1}{M} \sum_{s=0}^{M-1} (X(i)s)^2}$	$X_{rms(i)(+)} = \frac{1}{2} (X_{rms(i)} + X_{rms(i+1)})$		$X_{rms123} = \frac{1}{3} (X_{rms1} + X_{rms2} + X_{rms3})$ $X_{rms456} = \frac{1}{3} (X_{rms4} + X_{rms5} + X_{rms6})$		
Voltage, current Mean value rectification RMS equivalent	$X_{mn(i)} = \frac{\sqrt{\pi}}{2\sqrt{2}} \frac{1}{M} \sum_{s=0}^{M-1} X(i)s $	$X_{mn(i)(+)} = \frac{1}{2} (X_{mn(i)} + X_{mn(i+1)})$		$X_{mn123} = \frac{1}{3} (X_{mn1} + X_{mn2} + X_{mn3})$ $X_{mn456} = \frac{1}{3} (X_{mn4} + X_{mn5} + X_{mn6})$		
Voltage, current AC component				$X_{act(i)} = \sqrt{(X_{rms(i)})^2 - (X_{dc(i)})^2}$		
Voltage, current Average value				$X_{dc(i)} = \frac{1}{M} \sum_{s=0}^{M-1} X(i)s$		
Voltage, current Fundamental wave component				$X1(i)$ for harmonic voltage and current in the harmonic formula		
Voltage and current peak values		$X_{pk+(i)} = X(i)s$ $X_{pk-(i)} = X(i)s$		Max. value for M items Min. value for M items		
Active power	$P(i) = \frac{1}{M} \sum_{s=0}^{M-1} (U(i)s \times I(i)s)$	$P(i)(+) = P(i) + P(i+1)$		$P_{123} = P1 + P2$ $P_{456} = P4 + P5$	$P_{123} = P1 + P2 + P3$ $P_{456} = P4 + P5 + P6$	
Apparent power	$S(i) = U(i) \times I(i)$	$S(i)(+) = S(i) + S(i+1)$	$S(i)(+) = \frac{\sqrt{3}}{2} (S(i) + S(i+1))$	$S_{123} = \frac{\sqrt{3}}{3} (S1 + S2 + S3)$ $S_{456} = \frac{\sqrt{3}}{3} (S4 + S5 + S6)$	$S_{123} = S1 + S2 + S3$ $S_{456} = S4 + S5 + S6$	
Reactive power	$Q(i) = S(i) - P(i)$	$Q(i)(+) = Q(i) + Q(i+1)$		$Q_{123} = Q1 + Q2$ $Q_{456} = Q4 + Q5$	$Q_{123} = Q1 + Q2 + Q3$ $Q_{456} = Q4 + Q5 + Q6$	
Power factor	$\lambda(i) = \frac{P(i)}{S(i)}$	$\lambda(i)(+) = \frac{P(i)(+)}{S(i)(+)}$		$\lambda_{123} = \frac{P_{123}}{S_{123}}$ $\lambda_{456} = \frac{P_{456}}{S_{456}}$	$\lambda_{123} = \frac{P_{123}}{S_{123}}$ $\lambda_{456} = \frac{P_{456}}{S_{456}}$	
Power phase angle	$\phi(i) = \cos^{-1} \lambda(i)$	$\phi(i)(+) = \cos^{-1} \lambda(i)(+)$		$\phi_{123} = \cos^{-1} \lambda_{123}$ $\phi_{456} = \cos^{-1} \lambda_{456}$	$\phi_{123} = \cos^{-1} \lambda_{123}$ $\phi_{456} = \cos^{-1} \lambda_{456}$	
Voltage and current ripple factor				$\frac{(X_{pk+(i)} - X_{pk-(i)})}{2 \times X_{dc(i)}} \times 100$		



X: Voltage U or Current I
(i): Measurement channel, M: Number of samples during synchronized timing period, s: Sample point number

Motor analysis formulae

Measurement parameters	Setting	Formula
Voltage	Analog DC	$\frac{1}{M} \sum_{s=0}^{M-1} A_s$ M: Number of samples during synchronized timing period; s: Sample point number
Pulse frequency	Pulse	Pulse frequency
Torque	Analog DC	$\frac{1}{M} \sum_{s=0}^{M-1} A_s \times \text{scaling setting}$ M: Number of samples during synchronized timing period; s: Sample point number
Frequency	Frequency	$\frac{(\text{Measurement frequency} - f_c \text{ setting})}{f_d \text{ setting}}$
RPM	Analog DC	$\frac{1}{M} \sum_{s=0}^{M-1} A_s \times \text{scaling setting}$ M: Number of samples during synchronized timing period; s: Sample point number
Motor power	Pulse	$\frac{S_i^{60 \times \text{pulse frequency}}}{S_i^{60 \times \text{pulse frequency}}} \times \text{Pulse count setting}$ The polarity sign si is acquired based on the A-phase pulse rising/falling edge and the B-phase pulse logic level (high/low) when direction of rotation detection is enabled in single mode.
Slip	Motor power	$\text{Torque} \times \frac{2 \times \pi \times \text{RPM}}{60} \times \text{unit coefficient}$ The unit coefficient is 1 if the torque unit is N·m, 1/1000 if mN·m, and 1000 if kN·m.
	Slip	$100 \times \frac{2 \times 60 \times \text{input frequency} - \text{RPM}}{2 \times 60 \times \text{input frequency}}$ The input frequency is selected from f1 to f6.

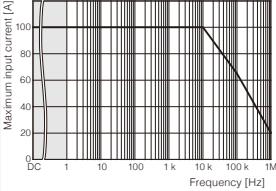
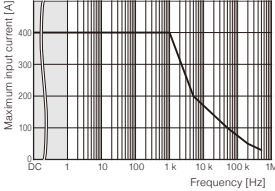
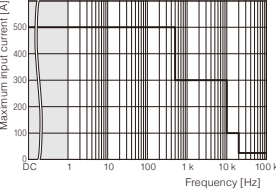
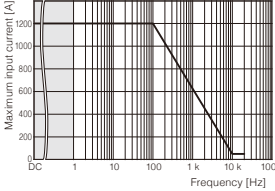
High accuracy sensor (connected to input terminal Probe 1)

Model	AC/DC CURRENT SENSOR CT6862-05	AC/DC CURRENT SENSOR CT6863-05	AC/DC CURRENT SENSOR 9709-05	AC/DC CURRENT SENSOR CT6865-05
Appearance				
Rated primary current	50 A AC/DC	200 A AC/DC	500 A AC/DC	1000 A AC/DC
Diameter of measurable conductors	Max.φ 24mm (0.94")	Max.φ 24 mm (0.94")	Max.φ 36 mm (1.42")	Max.φ 36 mm (1.42")
Basic accuracy	±0.05 %rdg.±0.01 % f.s. , ±0.2° (DC and 16 Hz to 400 Hz)		±0.05 %rdg.±0.01 % f.s. , ±0.2° (DC and 45 Hz to 66 Hz)	±0.05 %rdg.±0.01 % f.s. , ±0.2° (DC and 16 Hz to 66 Hz)
Frequency characteristics (Amplitude, typical)	DC to 16 Hz : ±0.1%rdg. ±0.02%f.s. 50 kHz to 100 kHz : ±2.0%rdg. ±0.05%f.s. 700 kHz to 1 MHz : ±30%rdg. ±0.05%f.s.	DC to 16 Hz : ±0.1%rdg. ±0.02%f.s. 50 kHz to 100 kHz : ±5%rdg. ±0.02%f.s. 300 kHz to 500 kHz : ±30%rdg. ±0.05%f.s.	DC to 45 Hz : ±0.2%rdg. ±0.02%f.s. 5 kHz to 10 kHz : ±2%rdg. ±0.1%f.s. 20 kHz to 100 kHz : ±30%rdg. ±0.1%f.s.	DC to 16 Hz : ±0.1%rdg. ±0.02%f.s. 500 Hz to 5 kHz : ±5%rdg. ±0.05%f.s. 10 kHz to 20 kHz : ±30%rdg. ±0.1%f.s.
Operating Temperature	-30°C to 85°C (-22°F to 185°F)	-30°C to 85°C (-22°F to 185°F)	0°C to 50°C (-32°F to 122°F)	-30°C to 85°C (-22°F to 185°F)
Effect of conductor position	Within ±0.01%rdg. (DC to 100 Hz)	Within ±0.01%rdg. (DC to 100 Hz)	Within ±0.05%rdg. (DC 100 A)	Within ±0.05%rdg. (AC1000 A,50/60 Hz)
Effects of external magnetic fields	10 mA equivalent or lower (400 A/m, 60 Hz and DC)	50 mA equivalent or lower (400 A/m, 60 Hz and DC)	50 mA equivalent or lower (400 A/m, 60 Hz and DC)	200 mA equivalent or lower (400 A/m, 60 Hz and DC)
Maximum rated voltage to earth	CAT III 1000 Vrms	CAT III 1000 Vrms	CAT III 1000 Vrms	CAT III 1000 Vrms
Dimensions	70W (2.76") × 100H (3.94") × 53D (2.09") mm		160W (6.30") × 112H (4.41") × 50D (1.97") mm	
Mass	Approx. 340 g (12.0 oz.)	Approx. 350 g (12.3 oz.)	Approx. 850 g (30.0 oz.)	Approx. 980 g (35.3 oz)
Derating properties				

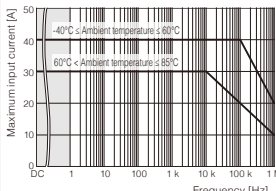
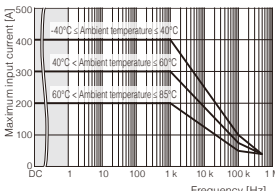
Model	AC/DC CURRENT PROBE CT6841-05	AC/DC CURRENT PROBE CT6843-05
Appearance		
Rated primary current	20 A AC/DC	200 A AC/DC
Diameter of measurable conductors	Max.φ 20 mm (0.79")	Max.φ 20 mm (0.79")
Basic accuracy	±0.3% rdg. ±0.01% f.s., ±0.1° (DC < I ≤ 100 Hz) ±0.3% rdg. ±0.05% f.s., (DC)	±0.3% rdg. ±0.01% f.s., ±0.1° (DC < I ≤ 100 Hz) ±0.3% rdg. ±0.02% f.s., (DC)
Frequency characteristics (Amplitude, typical)	100 Hz to 1 kHz : ±0.5%rdg. ±0.02%f.s. 1 kHz to 10 kHz : ±1.5%rdg. ±0.02%f.s. 10 kHz to 100 kHz : ±5.0%rdg. ±0.05%f.s. 100 kHz to 300 kHz : ±10%rdg. ±0.05%f.s. 300 kHz to 1 MHz : ±30%rdg. ±0.05%f.s.	100 Hz to 1 kHz : ±0.5%rdg. ±0.02%f.s. 1 kHz to 10 kHz : ±1.5%rdg. ±0.02%f.s. 10 kHz to 50 kHz : ±5.0%rdg. ±0.02%f.s. 50 kHz to 300 kHz : ±15%rdg. ±0.05%f.s. 300 kHz to 500 kHz : ±30%rdg. ±0.05%f.s.
Operating Temperature	-40°C to 85°C (-40°F to 185°F)	
Effect of conductor position	Within ±0.1%rdg. (DC to 100 Hz)	
Effects of external magnetic fields	0.05 A equivalent or lower (400 A/m, 60Hz and DC)	
Dimensions	153W (6.02") × 67H (2.64") × 25D (0.98") mm	
Mass	Approx. 350 g (12.3 oz)	Approx. 370 g (13.1 oz)
Derating properties		

Conversion cables

CONVERSION CABLE CT9900 is required to connect the following current sensors to the high accuracy sensor terminal.

For use with CT6862, CT6863, 9709, CT6865, CT6841, CT6843
When using a sensor without "-05" in the model name, Conversion Cable CT9900 must be used to make the connection.

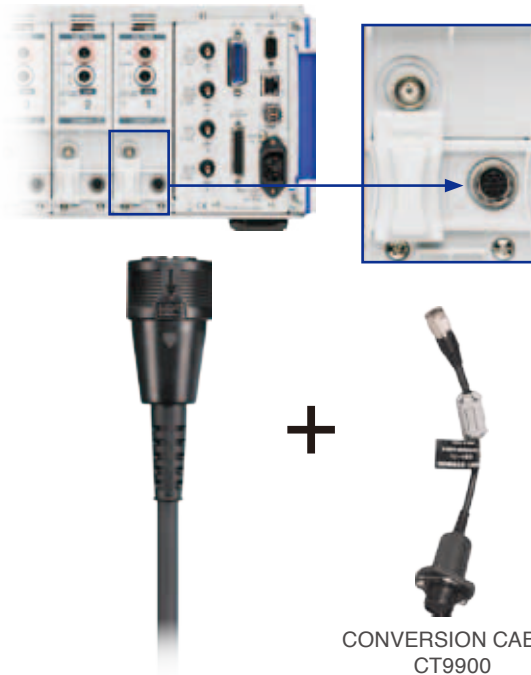

CONVERSION CABLE
CT9900

Broadband probe (connected to input terminal Probe 2)

Model	CLAMP ON PROBE 3273-50	CLAMP ON PROBE 3274	CLAMP ON PROBE 3275	CLAMP ON PROBE 3276
Appearance				
Frequency band	DC to 50 MHz (-3dB)	DC to 10 MHz (-3dB)	DC to 2 MHz (-3dB)	DC to 100 MHz (-3dB)
Rated primary current	30 A AC/DC	150 A AC/DC	500 A AC/DC	30 A AC/DC
Diameter of measurable conductors	5 mm dia. or less (insulated conductors)	20 mm dia. or less (insulated conductors)	20 mm dia. or less (insulated conductors)	5 mm dia. or less (insulated conductors)
Basic accuracy	0 to 30 A rms $\pm 1.0\%$ rdg. ± 1 mV 30 A rms to 50 A peak $\pm 2.0\%$ rdg. (At 45 to 66 Hz, DC)	0 to 150 A rms $\pm 1.0\%$ rdg. ± 1 mV 150 A rms to 300 A peak $\pm 2.0\%$ rdg. (At 45 to 66 Hz, DC)	0 to 500 A rms $\pm 1.0\%$ rdg. ± 5 mV 500 A rms to 700 A peak $\pm 2.0\%$ rdg. (At 45 to 66 Hz, DC)	0 to 30 A rms $\pm 1.0\%$ rdg. ± 1 mV 30 A rms to 50 A peak $\pm 2.0\%$ rdg. (At 45 to 66 Hz, DC)
Operating temperature and humidity	0°C to 40°C (32°F to 104°F) 80% rh or less (no condensation)	0°C to 40°C (32°F to 104°F) 80% rh or less (no condensation)	0°C to 40°C (32°F to 104°F) 80% rh or less (no condensation)	0°C to 40°C (32°F to 104°F) 80% rh or less (no condensation)
Effects of external magnetic fields	Max. 20 mA or equivalent (400 A/m, 60 Hz and DC)	Max. 150 mA or equivalent (400 A/m, 60 Hz and DC)	Max. 800 mA or equivalent (400 A/m, 60 Hz and DC)	Max. 5 mA or equivalent (400 A/m, 60 Hz and DC)
Dimensions	175W (6.89") x 18H(0.71") x 40D (1.57") mm Cable length: 1.5 m	176W (6.93") x 69H (2.72") x 27D(1.06") mm Cable length: 2 m	176W (6.93") x 69H (2.72") x 27D(1.06") mm Cable length: 2 m	175W (6.89") x 18H(0.71") x 40D (1.57") mm Cable length: 1.5 m
Mass	Approx. 230 g (8.1 oz)	Approx. 500 g (17.6 oz)	Approx. 520 g (18.3 oz)	Approx. 240 g (8.5 oz)
Derating properties				

	CURRENT PROBE CT6700	CURRENT PROBE CT6701
Appearance		
Frequency band	DC to 50 MHz (-3dB)	DC to 120 MHz (-3dB)
Rated primary current	5 Arms AC/DC	5 Arms AC/DC
Diameter of measurable conductors	5 mm dia. or less (insulated conductors)	5 mm dia. or less (insulated conductors)
Basic accuracy	typical $\pm 1.0\%$ rdg. ± 1 mV $\pm 3.0\%$ rdg. ± 1 mV (At 45 to 66 Hz, DC)	typical $\pm 1.0\%$ rdg. ± 1 mV $\pm 3.0\%$ rdg. ± 1 mV (At 45 to 66 Hz, DC)
Operating temperature and humidity	0°C to 40°C (32°F to 104°F) 80% rh or less (no condensation)	0°C to 40°C (32°F to 104°F) 80% rh or less (no condensation)
Effects of external magnetic fields	Max. 20 mA or equivalent (400 A/m, 60 Hz and DC)	Max. 5 mA or equivalent (400 A/m, 60 Hz and DC)
Dimensions	155W (6.10") x 18H(0.71") x 26D (1.02") mm Cable length: 1.5 m	155W (6.10") x 18H(0.71") x 26D (1.02") mm Cable length: 1.5 m
Mass	Approx. 250 g (8.8 oz)	Approx. 250 g (8.8 oz)
Derating properties		

Sensor switching method

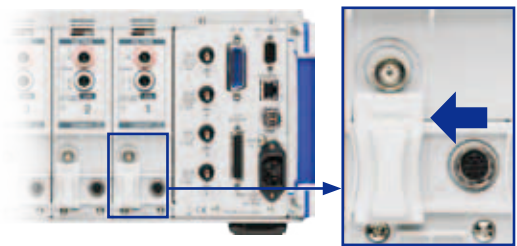

High accuracy sensor terminal: Slide the cover to the left.

When connecting CT6862-05, CT6863-05, 9709-05, CT6865-05, CT6841-05 or CT6843-05

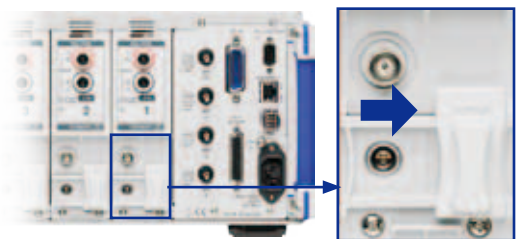

Wideband probe terminal: Slide the cover to the right.

When connecting 3273-50, 3274, 3275, 3276, CT6700 or CT6701

Configurations

Model	Order Code	Number of built-in channels	Motor analysis & D/A output
POWER ANALYZER	PW6001-01	1ch	—
	PW6001-02	2ch	—
	PW6001-03	3ch	—
	PW6001-04	4ch	—
	PW6001-05	5ch	—
	PW6001-06	6ch	—
	PW6001-11	1ch	✓
	PW6001-12	2ch	✓
	PW6001-13	3ch	✓
	PW6001-14	4ch	✓
	PW6001-15	5ch	✓
	PW6001-16	6ch	✓



PW6001-16 (with 6 channels and motor analysis & D/A output)

Accessories: Instruction manual × 1, power cord × 1, D-sub 25-pin connector (PW6001-11 to -16 only) × 1

- The optional voltage cord and current sensor are required for taking measurements.
- Specify the number of built-in channels and inclusion of Motor analysis & D/A output upon order for factory installation. These options cannot be changed or added at a later date.

Current measurement options

Model	Rated primary current
AC/DC CURRENT SENSOR CT6862-05	50A
AC/DC CURRENT SENSOR CT6863-05	200A
AC/DC CURRENT SENSOR 9709-05	500A
AC/DC CURRENT SENSOR CT6865-05	1000A
AC/DC CURRENT PROBE CT6841-05	20A
AC/DC CURRENT PROBE CT6843-05	200A
CLAMP ON PROBE 3273-50	30A
CLAMP ON PROBE 3274	150A
CLAMP ON PROBE 3275	500A
CLAMP ON PROBE 3276	30A
CURRENT PROBE CT6700	5A
CURRENT PROBE CT6701	5A

CONVERSION CABLE CT9900



For use with CT6862, CT6863, 9709, CT6865, CT6841, CT6843
When using a sensor without "-05" in the model name, Conversion Cable CT9900 must be used to make the connection.

Voltage measurement options

VOLTAGE CORD L9438-50

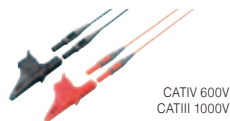

Red, black: 1 each
1000 V specifications
Cable length: 3 m (9.84 ft)

VOLTAGE CORD L1000

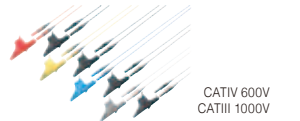

Red, yellow, blue, gray: 1 each; Black: 4
1000 V specifications
Cable length: 3 m (9.84 ft)

GRABBER CLIP 9243



Red, black: 1 each
Change the tip of the VOLTAGE CORD to use

Connection options

CONNECTION CORD L9217



Length : 1.6 m (5.25 ft)
For motor signal input

LAN CABLE 9642



Length : 5 m (16.41 ft)
supplied with straight to cross conversion cable

RS-232C CABLE 9637



Length: 1.8 m (5.91 ft)
9pin to 9pin

GP-IB CONNECTOR CABLE 9151-02



Length: 2 m (6.56 ft)

CONNECTION CABLE 9444



Length: 1.5 m (4.92 ft)
For external control interface straight 9pin to 9pin

OPTICAL CONNECTION CABLE L6000



Length: 10 m (32.8 ft)
For synchronized control

Other

The following made-to-order items are also available. Please contact your Hioki distributor or subsidiary for more information.

- Optical connection cable, Max. 500 m (1640.55 ft) length
- Rackmount fittings (EIA, JIS)
- Carrying case (hard trunk, with casters)



Carrying case

Note: Company names and Product names appearing in this catalog are trademarks or registered trademarks of various companies.

HIOKI

HIOKI E. E. CORPORATION

HEADQUARTERS

81 Koizumi, Ueda, Nagano, 386-1192, Japan
TEL +81-268-28-0562 FAX +81-268-28-0568
http://www.hioki.com / E-mail: os-com@hioki.co.jp

HIOKI USA CORPORATION

TEL +1-609-409-9109 FAX +1-609-409-9108
http://www.hiokiusa.com / E-mail: hioki@hiokiusa.com E-mail: info-kr@hioki.co.jp

HIOKI (Shanghai) SALES & TRADING CO., LTD.
TEL +86-21-63910090 FAX +86-21-63910360
http://www.hioki.cn / E-mail: info@hioki.com.cn

HIOKI INDIA PRIVATE LIMITED
TEL +91-124-6590210
E-mail: hioki@hioki.in

HIOKI SINGAPORE PTE. LTD.
TEL +65-6634-7677 FAX +65-6634-7477
E-mail: info-sg@hioki.com.sg

DISTRIBUTED BY

서울본사
서울특별시 영등포구 경인로 775(문래동 3가, 에이스하이테크시티 3동 201호)
TEL: 070-7872-0701 FAX: 02-2167-3801
E-mail: sales@nubicom.co.kr

(주)누빅콤

고객지원센터
TEL: 070-7872-0701, 080-801-7880 FAX: 02-2167-3802
E-mail: oft@nubicom.co.kr

대전 사무소
대전광역시 유성구 대덕대로 593(도룡동 386-2) 대덕테크비즈니스센터 203호
TEL: 070-7872-0712 FAX: 042-863-2023
E-mail: inyeom@nubicom.co.kr