

IM7580 series

IMPEDANCE ANALYZER

Maximum speed **0.5ms***



High-speed, highly stable measurement

Achieve fast and stable measurement through high-speed measurements and excellent repeatability.
Cut takt time and increase productivity.

All models
Maximum speed **0.5ms**
(Analog measurement time)



Repeatability and analog measurement time
(Reference data for various measurement frequencies)

■ IM7583, IM7585 ■ IM7580A, IM7581

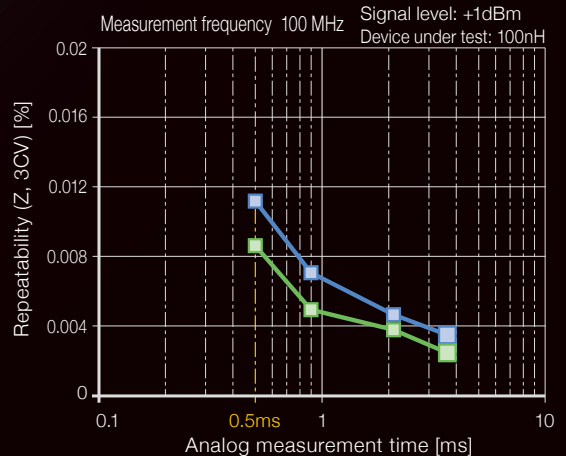
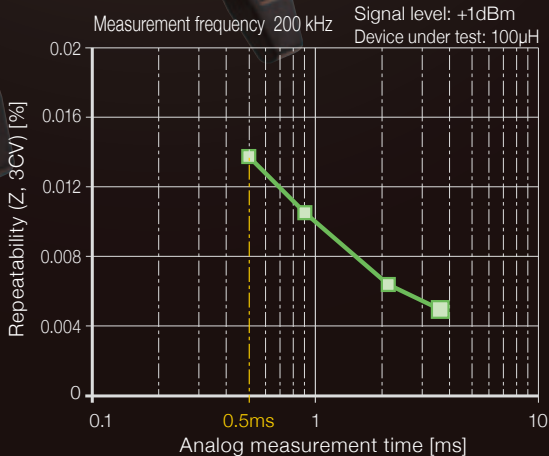
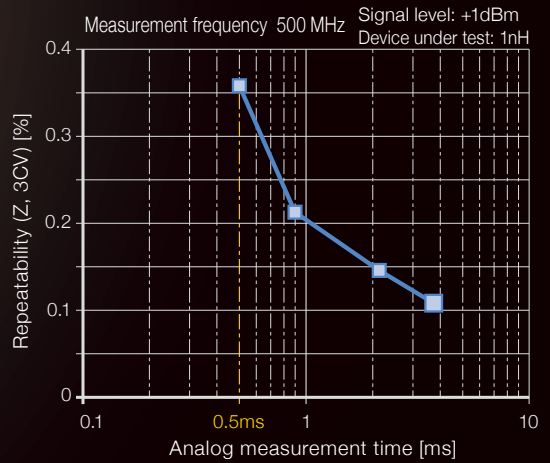
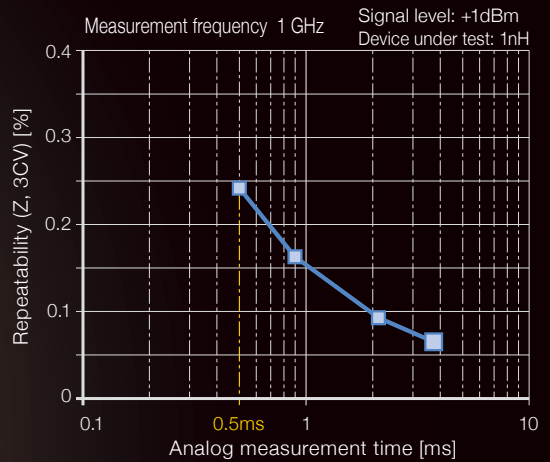

Space-saving Half-rack Size

Compact form factor – 2 analyzers fit side-by-side on a full-size rack.

Cut takt time and increase productivity.

Use them together to smoothly make a complete range of measurements.



Compact body for greater mobility

The half-rack compact body is light and fit not only for line use, but also when measuring various sites on foot.

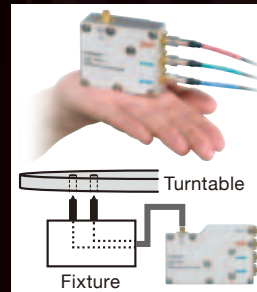

Test head fits in the palm of your hand

The slim profile of the test head lets you install it close to the measurement target to help minimize influence from noise and other effects and enabling more accurate measurement.



Large display for easy operation

Customize the large screen according to desired brightness, color, and text size to fit your environment. Highly responsive touch screen makes measurement settings and adjustments even easier.



Number of display digits (3/4/5/6)
Absolute value display

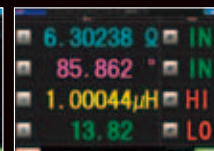

Customizable text size



Customizable display color (Background and display colors)

Choose from 4 Models

A complete product line to fully meet your measurement frequency and applications.



Photo: IM7581

IMPEDANCE ANALYZER IM7580A

Measurement frequency	1 MHz to 300 MHz
Measurement range	L : 0.0531 nH to 2.65 μ H C : 0.107 pF to 5.30 nF (When measurement frequency = 300 MHz)
Measurement signal level	-40.0 dBm to +7.0 dBm
Basic accuracy	Z : 0.72% rdg. θ : 0.41°

IMPEDANCE ANALYZER IM7581

Measurement frequency	100 kHz to 300 MHz
Measurement range	L : 160 nH to 7.95 mH C : 319 pF to 15.9 μ F (When measurement frequency = 100 kHz)
Measurement signal level	-40.0 dBm to +7.0 dBm
Basic accuracy	Z : 0.72% rdg. θ : 0.41°



Photo: IM7585

IMPEDANCE ANALYZER IM7583

Measurement frequency	1 MHz to 600 MHz
Measurement range	L : 0.0266 nH to 1.32 μ H C : 0.0531 pF to 2.65 nF (When measurement frequency = 600 MHz)
Measurement signal level	-40.0 dBm to +1.0 dBm
Basic accuracy	Z : 0.65% rdg. θ : 0.38°

IMPEDANCE ANALYZER IM7585

Measurement frequency	1 MHz to 1.3 GHz
Measurement range	L : 0.0123 nH to 612 nH C : 0.0245 pF to 1.22 nF (When measurement frequency = 1.3 GHz)
Measurement signal level	-40.0 dBm to +1.0 dBm
Basic accuracy	Z : 0.65% rdg. θ : 0.38°

A rich lineup covering a wide range of measurement frequencies

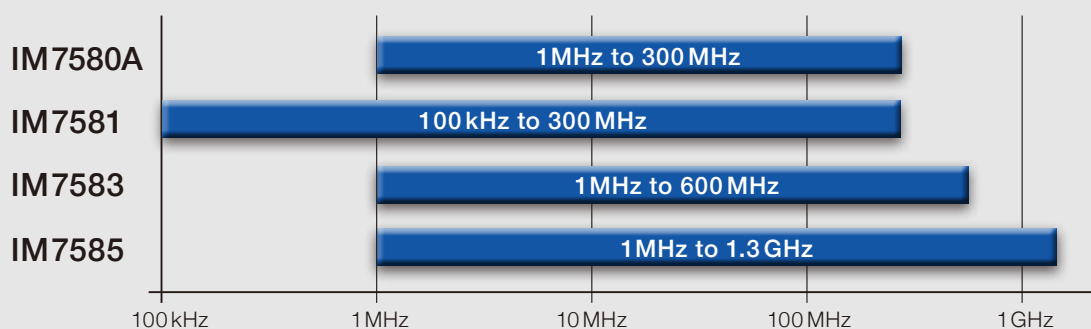

Dual measurement modes

Measure up to four measurement parameters simultaneously.

Z Impedance	G Conductance	Rp Equivalent parallel resistance	Cp Equivalent parallel capacitance
Y Admittance	B Susceptance	Ls Equivalent series inductance	D Loss factor tan δ
θ Phase angle	Q Q-factor	Lp Equivalent parallel inductance	V Monitor voltage*
X Reactance	Rs Equivalent series resistance (ESR)	Cs Equivalent series capacitance	I Monitor current*

*Analyzer mode only

LCR Mode

Use LCR Mode to make measurements by applying the desired frequency and level signal to the component being measured. This mode is ideal for evaluating passive devices such as capacitors and coils.

Comparator measurement : Yield a PASS/FAIL judgment for the target component based on a single judgment criterion.

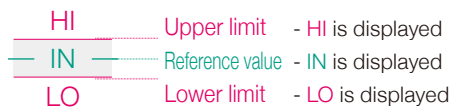
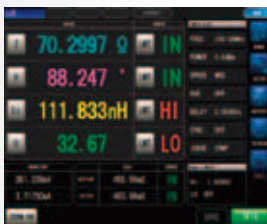

Upper and lower limit judgment: Set the upper and lower limits.
 Percentage judgment: Set the upper and lower limits as percentages of the reference value.
 Deviation percentage judgment: Set the upper and lower limits as percentages of the reference value. The impedance analyzer will display deviation of the measured value from the reference value (Δ%).

Display

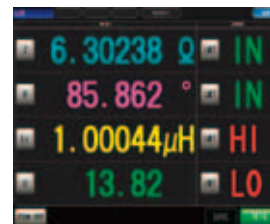

Zoom function

Display measured values using larger text for better visibility on production lines and in other field applications.

Bim measurement : Rank components using multiple judgment criteria.

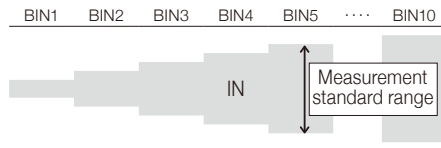
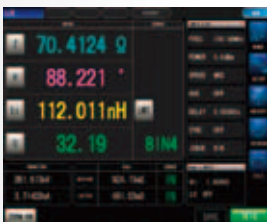

Set upper and lower limits for each bin. The impedance analyzer will rank components using up to 10 categories.
 *Upper and lower limit settings are the same as for comparator measurement.

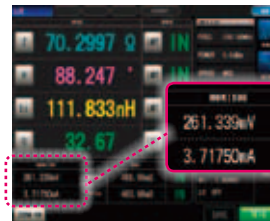

Monitor function

Display the measurement signal level being applied to components in real time.

Monitor voltage : 0.0 mV to 1000.0 mV
 Monitor current : 0.000 mA to 20.000 mA

Analyzer Mode

Use Analyzer Mode to perform measurement while sweeping through a range of measurement frequencies and measurement signal levels. This mode is ideal for checking frequency characteristics and level characteristics.

Normal / segment sweep operation : Discover component characteristics by sweeping through a range of frequencies and levels.

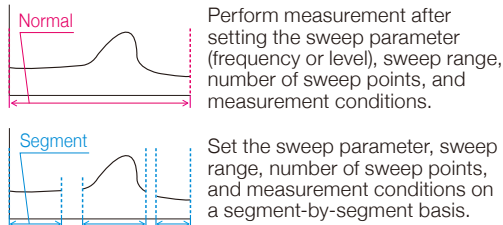

Sweep parameters	Frequency/signal level (power, voltage, current)
Number of sweep points/segments	Up to 801 points / Up to 20 segments (with a total of 801 points)
Measurement condition settings	Frequency, level, speed, average

Interval sweep operation : Discover element characteristics over time under set conditions.

Measurement condition settings	Frequency, level, speed, average
Time interval	0 sec. to 1,000 sec.
Number of sweep points/segments	Up to 801 points / Up to 20 segments (with a total of 801 points)

Display



The graph display can be switched based on the type of measurement being performed. (with a total of 7 layouts available)

- Sweep graph display (1-graph/4-graph display),
- XY graph display (1-graph/2-graph display),
- Multi-display (simultaneous display of sweep and XY),
- List display, Peak display

Intelligent measurement and analysis

Convenient functionality for performing measurement, reviewing measurement results, and judging measured values.

- Functions available in analyzer mode
- Functions available in LCR mode

Continuous measurement function

Perform continuous measurement in the order of the measurement conditions saved with the panel save function. Measurements can combine LCR and Analyzer Mode measurement conditions.



A: Panel numbers set for continuous measurement;
B: Measured values; C: Parameter judgment results

Continuous measurement can be performed using up to 46 measurement condition combinations, and can be implemented from EXT I/O.



Panel save and load function

Save or load the measurement conditions, compensation values, and compensation conditions set in LCR mode or analyzer mode.

Number of panels that can be saved

LCR Mode measurement conditions	30
Analyzer Mode measurement conditions	16

Measured value search function

The cursor can be moved automatically to a user-selected measured value point for one set of sweep measurement results.

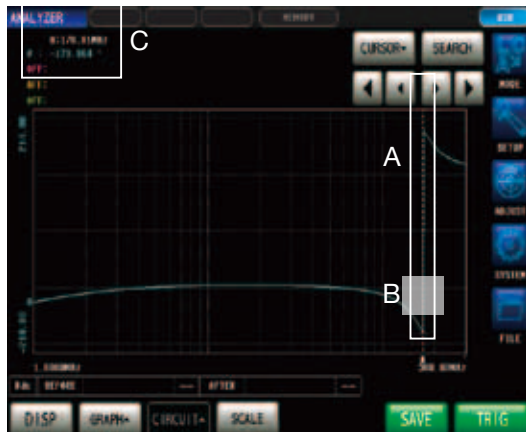

A: Cursor; B: Search result point; C: Measured values at result point

Search options

Maximum value	Moves the cursor to the maximum value.
Minimum value	Moves the cursor to the minimum value.
Target	Moves the cursor to a user-set measured value.
L-Max value	Moves the cursor to the local maximum value (a filter can be set).
L-Min value	Moves the cursor to the local minimum value (a filter can be set).

Select a measurement parameter to search.

Select the search type.
(If target, enter the value.)

Select whether to search for a rising waveform or falling waveform.

Select whether to use a filter.
(Local maximum and local minimum values only)

Auto search function

Move the cursor automatically according to user-configured settings once sweep measurement is complete.

Area and peak comparison functions

Check whether measured values fall inside a previously configured judgment area. These functions are ideal for use in verifying non-defective products.

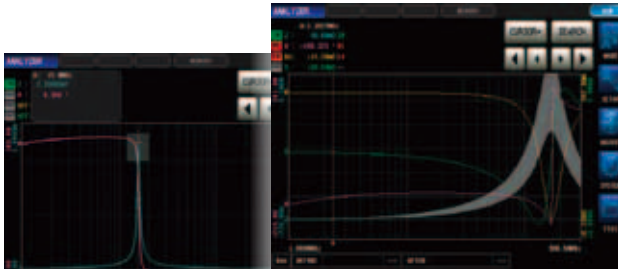

Peak judgment screen

Area judgment screen

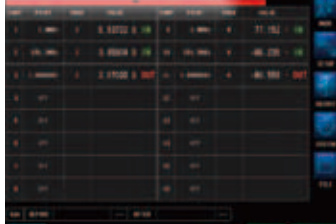

Spot judgment screen

Area judgment

Obtaining an overall judgment for each sweep

Define a range by setting upper and lower limits and display the judgment results as IN or NG.

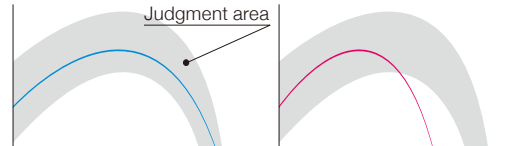

Peak judgment

Identifying resonance points

Define a range by setting upper, lower, left, and right limits and display the judgment results as IN or NG.

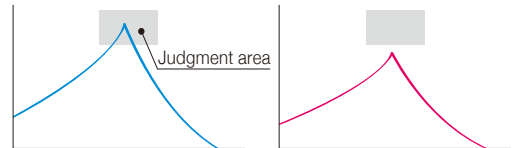

Spot judgment

For multiple-frequency simultaneous judgments

This function makes a judgment at a pre-set point during sweeping. (Up to 16 points)

Equivalent circuit analysis function

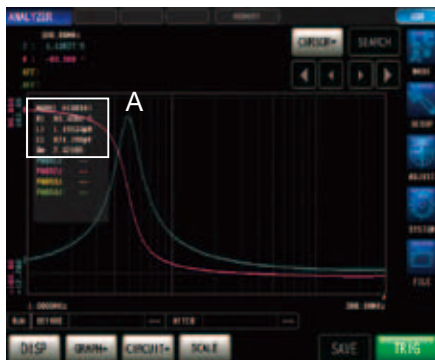

A: Analysis results

Analyze individual component values (L/C/R) for elements in the following five circuits based on measurement results.

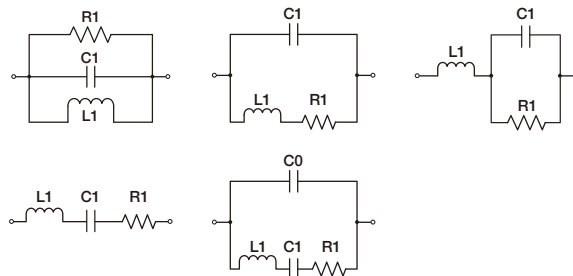

Simulation function/residual error display

Perform a simulation based on equivalent circuit analysis results and compare the results to measured values to verify their accuracy. The residual error display allows you to check the quantitative difference between measured values and simulation results.

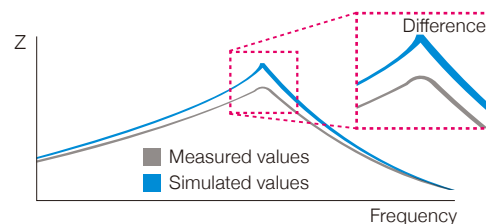

Functions for Accurate Measurement

Fully equipped with a range of built-in functions necessary for accurate and stable measurement.

Contact check



The impedance analyzer checks the state of contact between the measurement terminals and circuit elements to verify integrity and detect contact errors.

DCR measurement

Checking contact before and after measurement

This capability is ideal for carrying out contact checks of inductive components with low DC resistance values such as inductors, ferrite cores, and common-mode filters.

Judgments based on user-configured upper and lower contact resistance limits

Guaranteed accuracy range	0.1 Ω to 100 Ω
Measurement timing	Before measurement, after measurement, or before and after measurement

HI	485.98mΩ	IN	Measured value > Upper limit: Displays "HI."
LO	483.98mΩ	IN	Upper limit ≥ Measured value ≥ Lower limit: Displays "IN."
			Measured value < Lower limit: Displays "LO."

Hi-Z reject function

Judging the contact state based on measurement results

Activate this function in order to output a measurement terminal contact error if the impedance measured value is greater than a user-configured reference value.

Valid setting range	1 Ω to 10000 Ω
---------------------	----------------

Waveform judgment function

Detecting chatter during measurement

Verify that components and terminals are in contact during measurement. The impedance analyzer will output an error if fluctuations in the RMS value exceed a user-configured range that has been set using the initially acquired RMS value waveform as the reference value.

Valid setting range	0.01% to 100.0% of the reference value
Output format	Screen error display or EXT I/O error output

Compensation function

To truly measure accurately, all analyzers should first be set up to their optimal state.

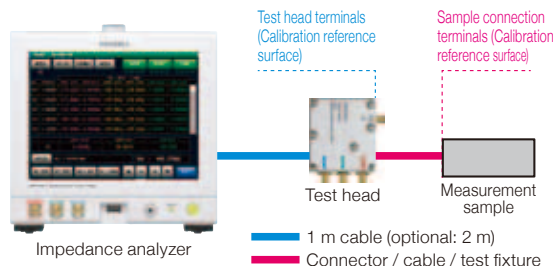

Open, short, and load calibration

The compensation process involves calibrating the measurement setup, from the impedance analyzer to the reference surface (either the test head terminals or the sample connection terminals). Each of three standards (open, short, and load) is connected and its calibration data measured to eliminate potential sources of error.

Electrical length compensation

Enter the length of the electrical connection between the reference surface and the measurement sample connection surface to allow compensation of error caused by phase shift. If mounting a fixture on the test head, it is necessary to enter the fixture's electrical length.

Open and short compensation

Eliminate the causes of errors (such as fixtures or measurement cables) from the calibration standard surface to the sample connection terminal.

External control I/O

When using external control, you can regulate the input and output signal timing as desired.

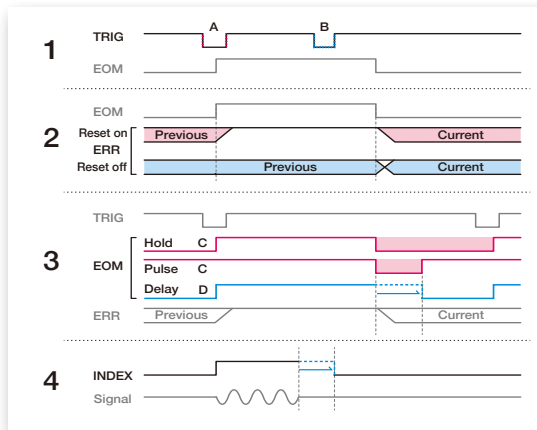

1. Trigger input Timing and enable/disable settings

- A Choose to enable or disable trigger input during measurement. By disabling input, you can prevent erroneous input caused by chatter.
- B Select whether to base input timing on the trigger's rising edge or falling edge.

2. Reset judgment result

- You can set the timing at which judgment results are reset.
- On: Reset the previous judgment results at the measurement complete signal's rising edge.
- Off: Reset the previous judgment results when the next judgment results are output.

3. Measurement complete signal

Output method and output delay

- C Select whether to use pulse or hold output for the measurement complete signal.
- Pulse: You can set the duration for which the measurement complete signal is placed in the "on" state.
- Hold: The measurement complete signal switches from "on" to "off" at trigger input.
- D You can set the duration of the delay from output of judgment results to output of the measurement complete signal.

4. Analog measurement signal Output delay

When using trigger-synchronized output, you can ensure that the analog measurement signal is only output once the measurement signal has turned off.

Trigger-synchronized output: The measurement signal is only applied to the sample during measurement.

Key lock function

Lock the instrument's keys to prevent erroneous or unauthorized screen operation.



Full key lock	Disables all setting changes.
Set key lock	Enables only comparator and bin judgment settings.

*Before activating the key lock function, check the passcode setting.

Audio Signal

Turn the beep tone on or off based on the comparator judgment results.

The key tone can also be turned on or off.
Beep types: 14 Volume: 3 settings

Warm-up function

The impedance analyzer will display a message indicating that warm-up operation is complete about 60 minutes after it is powered on.

(A warm-up period of 60 minutes is required in order for the instrument to perform at its defined accuracy.)

Rich Array of Interfaces

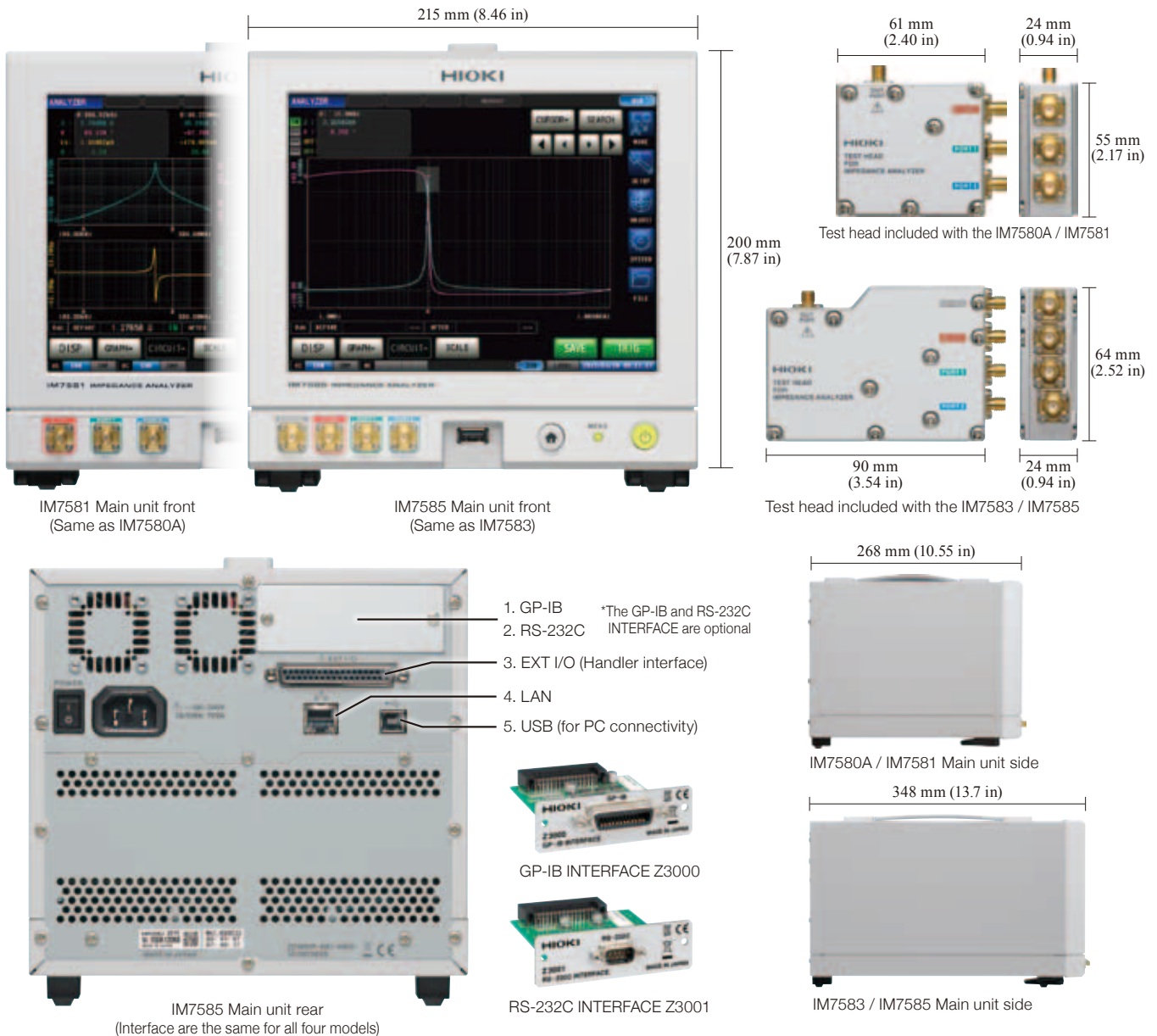

IM7581 Main unit front
(Same as IM7580A)

IM7585 Main unit front
(Same as IM7583)

Test head included with the IM7580A / IM7581

Test head included with the IM7583 / IM7585

IM7585 Main unit rear
(Interface are the same for all four models)

IM7580A / IM7581 Main unit side

IM7583 / IM7585 Main unit side

1. GP-IB
 2. RS-232C
 3. EXT I/O (Handler interface)
 4. LAN
 5. USB (for PC connectivity)
- *The GP-IB and RS-232C INTERFACE are optional



GP-IB INTERFACE Z3000



RS-232C INTERFACE Z3001



Save measurement conditions and results in a USB flash drive

Use the front USB terminal to save the measurement data, screen shots, or measurement conditions saved to the unit's internal memory to a USB drive.

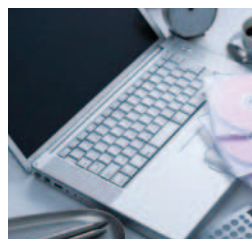

Extensive range of interfaces for external control

Use the IM7580's LAN, USB, GP-IB, RS-232C, and EXT I/O interfaces to control the instrument from an external device.

*The GP-IB and RS-232C INTERFACE are optional

LAN

Connector	RJ-45 connector
Transmission method	10Base-T, 100Base-Tx, 1000Base-T
Protocol	TCP/IP

USB (for PC connectivity)

Connector	USB Type B
Electrical specifications	USB 2.0 (High Speed)

GP-IB (optional)

CONNECTOR	24-PIN
STANDARD	IEEE 488.1 1987
REFERENCE STANDARD	IEEE 488.2 1987
TERMINATOR	CR+LF, LF

RS-232C (optional)

Connector	D-sub 9-pin
Flow control	Software
Transmission speed	9600 / 19200 / 38400 / 57600 bps

EXT I/O

Connector	D-sub 37-pin
	Female #4-40 inch thread
Compatible connectors	DC-37P-ULR (solder)
	DCSP-JB37PR (crimp)
	Japan Aviation Electronics Industry, Ltd.

*For more information, see page 15.

Applications

Common-mode filter measurement Panel save and continuous measurement

When one component must be measured two different ways or when compensation values and measurement conditions differ for each measurement point, the IM7580 series streamlines the measurement process by automatically switching among compensation values and measurement conditions.

When one component must be measured two different ways.

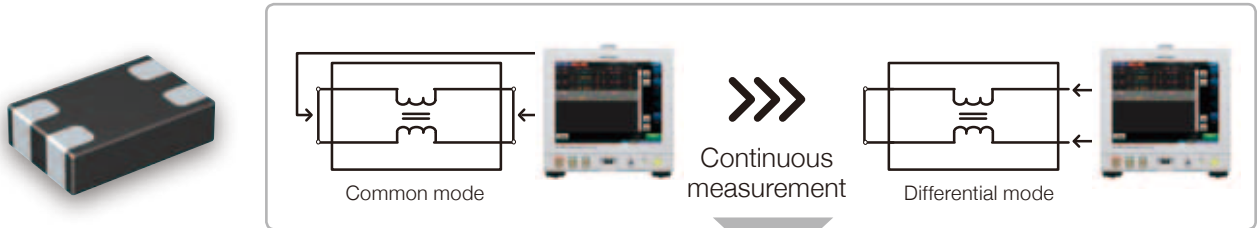

Halve cycle times by using two instruments...

Compact design that fits two instruments into a full-size rack. Using two impedance analyzers simultaneously can dramatically reduce cycle times.



When compensation values and measurement conditions differ for each measurement point

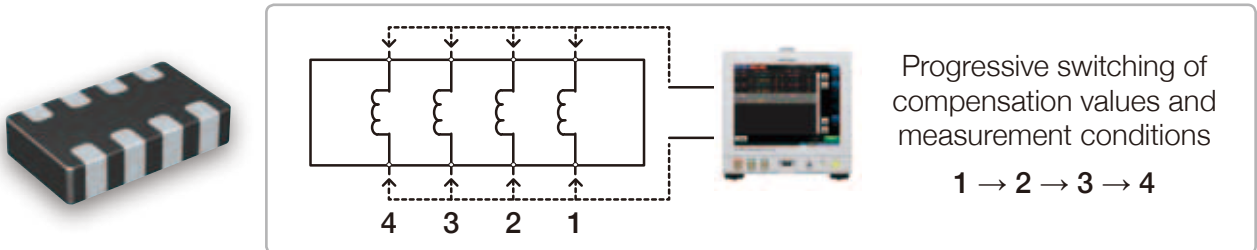

PASS/FAIL judgments of power inductors Comparator function

By using the comparator function's area and peak judgment functions, you can easily differentiate between defective and non-defective components.



Area judgment

Set the judgment area and then check whether component measurement results fall inside that area. This approach is well suited to differentiating between defective and non-defective components.

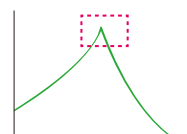
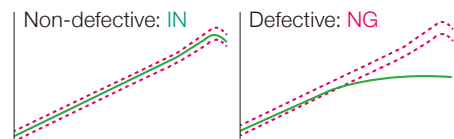

As illustrated to the left, you can set a range around the peak value and use it to make judgments.

Measurement parameters and measurement conditions

Measurement modes	LCR mode: Measurement using a single set of conditions Analyzer mode: Sweep measurement and equivalent circuit analysis Continuous measurement mode: Continuous measurement using previously saved conditions	
Measurement parameters	Z Impedance Y Admittance θ Phase angle X Reactance G Conductance B Susceptance Q Q-factor	Rs Equivalent series resistance (ESR) Rp Equivalent parallel resistance Ls Equivalent series inductance Lp Equivalent parallel inductance Cs Equivalent series capacitance Cp Equivalent parallel capacitance D Loss factor $\tan \delta$
Display range	Z 0.00 m to 9.99999 G Ω Y 0.000 n to 9.99999 GS θ $\pm(0.000^\circ$ to $999.999^\circ)$ X $\pm(0.00$ m to 9.99999 G Ω) G $\pm(0.000$ n to 9.99999 GS) B $\pm(0.000$ n to 9.99999 GS) Q $\pm(0.00$ to $9999.99)$	Rs $\pm(0.00$ m to 9.99999 G Ω) Rp $\pm(0.00$ m to 9.99999 G Ω) Ls $\pm(0.00000$ n to 9.99999 GH) Lp $\pm(0.00000$ n to 9.99999 GH) Cs $\pm(0.00000$ p to 9.99999 GF) Cp $\pm(0.00000$ p to 9.99999 GF) D $\pm(0.00000$ to $9.99999)$ $\Delta\%$ $\pm(0.000$ to $999.999\%)$
Measurable range	100 m Ω to 5 k Ω	
Output impedance	Approx. 50 Ω	
Measurement frequency	Range	IM7580A 1 MHz to 300 MHz IM7581 100 kHz to 300 MHz IM7583 1 MHz to 600 MHz IM7585 1 MHz to 1.3 GHz
	Resolution	IM7580A 1.0000 MHz to 9.9999 MHz 100 Hz steps 10.000 MHz to 99.999 MHz 1 kHz steps 100.00 MHz to 300.00 MHz 10 kHz steps IM7581 100.00 kHz to 999.99 kHz 10 Hz steps (1.0000 MHz to 300.00 MHz same as IM7580A) IM7583 / IM7585 100 kHz steps
	Accuracy	$\pm 0.01\%$ of setting or less
	Accuracy	$\pm 0.01\%$ of setting or less
Measurement signal level	Range	IM7580A / IM7581 Power : -40.0 dBm to +7.0 dBm Voltage : 4 mV to 1001 mV rms Current : 0.09 mA to 20.02 mA rms IM7583 / IM7585 Power : -40.0 dBm to +1.0 dBm Voltage : 4 mV to 502 mV rms Current : 0.09 mA to 10.04 mA rms *User-configured power, voltage, and current
	Resolution	0.1 dB steps
	Accuracy	± 2 dB(23 $^\circ\text{C} \pm 5$ $^\circ\text{C}$), ± 4 dB(0 $^\circ\text{C}$ to 40 $^\circ\text{C}$)

LCR mode

Measurements	Bin measurement: 10 categories for 4 measurement parameters
	Comparator measurement: Hi, IN, and Lo judgments for 4 parameters
Functionality	Monitor function Monitor voltage range: 0.0 mV to 1000.0 mV Monitor current range: 0.000 mA to 20.000 mA
Display	Zoom display function: Enlarged display of measured values

Analyzer mode

Measurements	Sweep measurement Up to 801 sweep points with user-configurable point delay Normal sweep: Measurement of up to 801 points Segment sweep: Up to 20 segments (with a total of 801 points)
	Time interval measurement Interval of 0.00000 sec. to max. 1,000.00 sec., 801 points
Functionality	Equivalent circuit analysis: 5 circuit models Cursor function: Automatically search for maximum and minimum values, target, local maximum and minimum values Comparator function: Area, peak and spot judgment
Display	List display graph display, XY graph display, judgment results display Scaling: Linear or logarithmic

Continuous measurement mode

Measurements	Continuous measurement using up to 46 combinations of the following measurement conditions: 30 LCR mode measurement conditions and 16 analyzer mode measurement conditions
--------------	---

Speed and accuracy

Measurement speed (analog measurement)	FAST	MED	SLOW	SLOW2
	0.5 ms	0.9 ms	2.1 ms	3.7 ms
Averaging	Valid setting range: 1 to 256 (in steps of 1)			
Basic accuracy	IM7580A / IM7581..... Z : 0.72% rdg. θ : 0.41 $^\circ$ IM7583 / IM7585 Z : 0.65% rdg. θ : 0.38 $^\circ$			
Guaranteed accuracy range	100 m Ω to 5 k Ω (impedance)			
Accuracy guaranteed	1 year, Post-adjustment accuracy guaranteed for 1 year			
Terminal design	2-terminal design			

Supplementary functionality

Trigger function	User-selectable internal or external trigger (EXT I/O, interface, manual) Trigger delay: 0 sec. to 9 sec. Trigger-synchronized output: Stabilization wait time of 0 sec. to 9 sec. INDEX signal delay time of 0 sec. to 0.1 sec. Trigger types: Sequential, repeat, step ^{*1}
Compensation function	Open/short/load calibration: From Main unit to test head Open/load compensation: Compensation of fixture component Electrical length compensation: 0 mm to 100 mm Correlation compensation: Compensation of display values based on user-input compensation coefficient
Contact check	DCR measurement, Hi-Z reject function, waveform judgment function

^{*1} Analyzer mode only

Recording and interface

Number of measured values that can be stored in memory	LCR Mode: 32000 Analyzer Mode: 100 sweeps
Panel save and load functions	Measurement conditions: 30 sets for LCR mode, 16 sets for Analyzer mode Compensation values only: 30 sets for LCR mode
Interfaces	HANDLER, USB, LAN, GP-IB (optional), RS-232C (optional)

Display and sound

Key lock function	Lock operation of the instrument using the panel. Unlock by entering a passcode.
Beep tone	Enable or disable for judgment results and key operation.
Warm-up function	The instrument will display a message 60 minutes after it is powered on.
Selection of number of display digits	3, 4, 5, or 6 digits
Display settings	LCD display on/off Backlight brightness adjustment Measurement screen background color (white or black) Switchable parameter colors
Display	8.4-inch color TFT with touch panel

Other

Operating temperature and humidity range	0 $^\circ\text{C}$ to 40 $^\circ\text{C}$ (32 $^\circ\text{F}$ to 104 $^\circ\text{F}$), 20% RH to 80% RH, non-condensing
Storage temperature and humidity range	-10 $^\circ\text{C}$ to 50 $^\circ\text{C}$ (14 $^\circ\text{F}$ to 122 $^\circ\text{F}$), 20% RH to 80% RH, non-condensing
Operating environment	Use indoors at an elevation of 2,000 m or less in an environment with a maximum pollution level of 2.
Power supply and maximum rated power	100 V to 240 V AC (50/60 Hz), 70 VA
Dielectric strength	1.62 kV AC for 1 min. between power line and ground line
Standards compliance	EMC: EN 61326, EN 61000 Safety: EN 61010
Dimensions and mass	IM7580A / IM7581 Approx. 215 Wx200 Hx268 D mm (8.46 Wx7.87 Hx10.55 D in), approx. 6.5 kg (229.3 oz) IM7583 / IM7585 Approx. 215 Wx200 Hx348 D mm (8.46 Wx7.87 Hx13.7 D in), approx. 8.0 kg (282.3 oz)
Accessories	Power cord x1, Instruction manual x1, Impedance analyzer application disc x1

Measurement accuracy

$$Z : \pm (E_a + E_b) [\%] \quad \theta : \pm 0.58 \times (E_a + E_b) [^\circ]$$

Conditions	
Guaranteed accuracy temperature and humidity range	0°C to 40°C (32°F to 104°F), 20% rh to 80% rh (non-condensing) However, must be within $\pm 5^\circ\text{C}$ of the temperature at the time of calibration.
Guaranteed accuracy period	1 year (with open/short/load calibration enabled)
Open/short/load calibration enabled period	Within 24 hours after calibration
Warm-up time	At least 60 min.
Measurement conditions	Frequency, power, and speed points at which open, short, and load calibration have been performed

IM7580A / IM7581

$$E_a = 1.0 + E_r \text{ (Frequency : 100kHz to 999.99kHz)}$$

$$E_a = 0.5 + E_r \text{ (Frequency : 1MHz to 300MHz)}$$

Frequency	Signal level	Er	α			
			FAST	MED	SLOW	SLOW2
100 kHz to 999.99 kHz	-7 dBm to +7 dBm	α	0.24	0.18	0.15	0.12
	-40 dBm to -7.1 dBm	$3 \times 10^{(-0.043P + \alpha)}$	-1.3	-1.4	-1.5	-1.6
1 MHz to 100 MHz	-7 dBm to +7 dBm	α	0.09	0.06	0.036	0.03
	-40 dBm to -7.1 dBm	$3 \times 10^{(-0.046P + \alpha)}$	-1.8	-2	-2.15	-2.3
100.01 MHz to 300 MHz	-7 dBm to +7 dBm	α	0.108	0.078	0.039	0.036
	-40 dBm to -7.1 dBm	$3 \times 10^{(-0.048P + \alpha)}$	-1.75	-1.9	-2.1	-2.26

P : Power setting [dBm]

$$E_b = \left(\left| \frac{Z_s}{Z_x} \right| + Y_o \cdot |Z_x| \right) \times 100 [\%] \quad (|Z_x| : Z \text{ measured value in } [\Omega])$$

$$Z_s = \frac{(Z_{sk} + Z_{sr} + 0.5 \times F)}{1000} [\Omega] \quad (F : \text{measurement frequency [MHz]})$$

Frequency	Zsk
100 kHz to 999.99 kHz	50
1 MHz to 300 MHz	20

Frequency	Signal level	Zsr	α			
			FAST	MED	SLOW	SLOW2
100 kHz to 999.99 kHz	-7 dBm to +7 dBm	α	36	27	21	15
	-40 dBm to -7.1 dBm	$3 \times 10^{(-0.042P + \alpha)}$	0.9	0.8	0.7	0.6
1 MHz to 300 MHz	-7 dBm to +7 dBm	α	13.5	9	5.1	3.9
	-40 dBm to -7.1 dBm	$3 \times 10^{(-0.048P + \alpha)}$	0.36	0.2	0	-0.15

P : Power setting [dBm]

$$Y_o = \frac{(Y_{ok} + Y_{or} + 0.15 \times F)}{1000000} [S] \quad (F : \text{measurement frequency [MHz]})$$

Frequency	Yok
100 kHz to 199.99 kHz	120
200 kHz to 300 MHz	30

Frequency	Signal level	Yor	α			
			FAST	MED	SLOW	SLOW2
100 kHz to 999.99 kHz	-7 dBm to +7 dBm	α	15	12	6.6	5.4
	-40 dBm to -7.1 dBm	$6 \times 10^{(-0.043P + \alpha)}$	0.6	0.5	0.4	0.3
1 MHz to 300 MHz	-7 dBm to +7 dBm	α	7.5	5.7	3.3	2.4
	-40 dBm to 7.1 dBm	$3 \times 10^{(-0.046P + \alpha)}$	0.1	0	-0.2	-0.4

P : Power setting [dBm]

IM7583 / IM7585

Ea :

Frequency	Signal level	Ea			
		FAST	MED	SLOW	SLOW2
1 MHz to 100 MHz	+1 dBm	0.581	0.557	0.532	0.524
	-22.9 dBm to +0.9 dBm	1.005	0.815	0.71	0.63
	-40 dBm to -23 dBm	3.622	2.501	1.7	1.43
100.1 MHz to 300 MHz	+1 dBm	0.652	0.634	0.621	0.616
	-22.9 dBm to +0.9 dBm	0.858	0.769	0.71	0.678
	-40 dBm to -23 dBm	1.72	1.336	1.06	0.85
300.1 MHz to 500 MHz	+1 dBm	0.652	0.634	0.621	0.616
	-22.9 dBm to +0.9 dBm	0.858	0.769	0.71	0.678
	-40 dBm to -23 dBm	1.72	1.336	1.06	0.85
500.1 MHz to 1.3 GHz	+1 dBm	0.86	0.841	0.823	0.818
	-22.9 dBm to +0.9 dBm	1.093	0.988	0.92	0.881
	-40 dBm to -23 dBm	2.068	1.625	1.31	1.16

$$Eb = \left(\frac{Zs}{|Zx|} + Yo \cdot |Zx| \right) \times 100 \text{ [%]} \quad (|Zx| : Z \text{ measured value in } [\Omega])$$

$$Zs = \frac{(Zsr + 0.5 \times F)}{1000} \text{ } [\Omega] \quad (F : \text{ measurement frequency [MHz]})$$

Frequency	Signal level	Zsr			
		FAST	MED	SLOW	SLOW2
1 MHz to 300 MHz	+1 dBm	41.7	37.6	34.3	32.3
	-22.9 dBm to +0.9 dBm	75.4	62.9	49.4	43.1
	-40 dBm to -23 dBm	495.66	293.25	185.7	142.05
300.1 MHz to 1000.0 MHz	+1 dBm	61.7	57.6	54.3	52.3
	-22.9 dBm to +0.9 dBm	95.4	82.9	69.4	63.1
	-40 dBm to -23 dBm	515.66	313.25	205.7	162.05
1000.1 MHz to 1.3 GHz	+1 dBm	111.7	107.6	104.3	102.3
	-22.9 dBm to +0.9 dBm	145.4	132.9	119.4	113.1
	-40 dBm to -23 dBm	565.66	363.25	255.7	212.05

$$Yo = \frac{(Yor + 0.15 \times F)}{1000000} \text{ } [S] \quad (F : \text{ measurement frequency [MHz]})$$

Frequency	Signal level	Yor			
		FAST	MED	SLOW	SLOW2
1 MHz to 300 MHz	+1 dBm	15.6	13.8	12.3	11.8
	-22.9 dBm to +0.9 dBm	48	35.6	25.5	21.7
	-40 dBm to -23 dBm	277.15	193.45	122.5	87.1
300.1 MHz to 1000.0 MHz	+1 dBm	35.6	33.8	32.3	31.8
	-22.9 dBm to +0.9 dBm	68	55.6	45.5	41.7
	-40 dBm to -23 dBm	297.15	213.45	142.5	107.1
1000.1 MHz to 1.3 GHz	+1 dBm	45.6	43.8	42.3	41.8
	-22.9 dBm to +0.9 dBm	78	65.6	55.5	51.7
	-40 dBm to -23 dBm	307.15	223.45	152.5	117.1

Basic measurement confirmation table

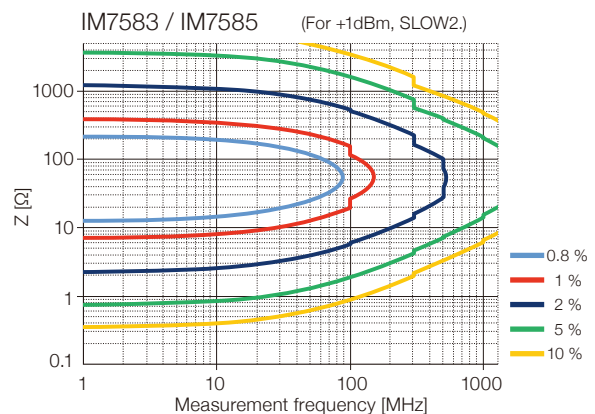
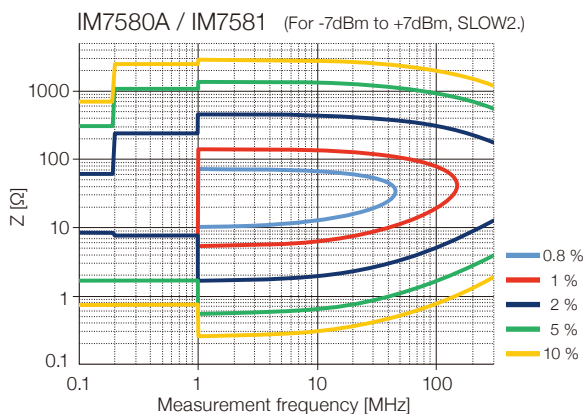

External control

List of EXT I/O handler interface signals

Pin	I/O	Signal
1	IN	TRIG
2	IN	Unused
3	IN	Unused
4	IN	LD1
5	IN	LD3
6	IN	LD5
7	IN	Unused
8	-	ISO_5V
9	-	ISO_COM
10	OUT	ERR
11	OUT	PARA1-HI,BIN1,PARA1-NG
12	OUT	PARA1-LO,BIN3,PARA2-NG
13	OUT	PARA2-IN,BIN5,PARA3-NG
14	OUT	AND,BIN7
15	OUT	PARA3-IN,BIN9,PARA4-IN
16	OUT	PARA4-HI
17	OUT	PARA4-LO
18	OUT	Unused
19	OUT	OUT_OF_BINS,CIRCUIT_NG
20	IN	Unused
21	IN	Unused
22	IN	LD0
23	IN	LD2
24	IN	LD4
25	IN	LD6
26	IN	LD_VALID
27	-	ISO_COM
28	OUT	EOM
29	OUT	INDEX
30	OUT	PARA1-IN,BIN2,PARA1-IN
31	OUT	PARA2-HI,BIN4,PARA2-IN
32	OUT	PARA2-LO,BIN6,PARA3-IN
33	OUT	PARA3-HI,BIN8,PARA4-NG
34	OUT	PARA3-LO,BIN10
35	OUT	PARA4-IN
36	OUT	Unused
37	OUT	Unused

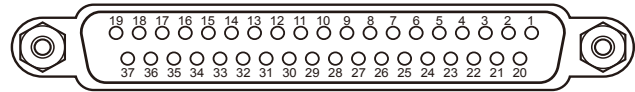

Signal	Function
TRIG	External trigger
LD0 to LD6	Panel number selection
EOM	Measurement complete signal
INDEX	Analog measurement complete signal
ERR	Detection level error
LD_VALID	Panel load
ISO_5V	Isolated power supply 5 V input
ISO_COM	Isolated power supply common
PARA1-HI to PARA4-HI	Comparator judgment result: HI judgment
PARA1-IN to PARA4-IN	Comparator judgment result: IN judgment
PARA1-LO to PARA4-LO	Comparator judgment result: LO judgment
OUT_OF_BINS	Bin measurement result
BIN1-BIN10	Bin judgment allocation: Bin 1 to Bin 10
CIRCUIT_NG	Equivalent circuit analysis: Comparator judgment result
PARA1-NG to PARA4-NG	Peak judgment result
PARA1-IN to PARA3-IN	Peak judgment result
AND	Result of applying a logical AND operation to judgment results for measured values for four parameters (output when all judgment results are IN)

Connector used	Compatible connectors
D-sub 37-pin	DC-37P-ULR (solder)
Female #4-40 inch thread	DCSP-JB37PR (crimp)
	Japan Aviation Electronics Industry, Ltd.

Electrical specifications	Input signals
	Photocoupler-isolated, no-voltage contact input Input "on" voltage: 0 V to 0.9 V / input "off" voltage: open or 5 V to 24 V
Output signals	Isolated NPN open collector output Maximum load voltage: 30 V / maximum output current: 50 mA/channel Residual voltage: 1 V or less (10 mA) or 1.5 V or less (50 mA)
Built-in isolated power supply	Voltage: 4.5 V to 5 V / maximum output current: 100 mA Floating relative to protective ground potential and measurement circuit

Timing chart

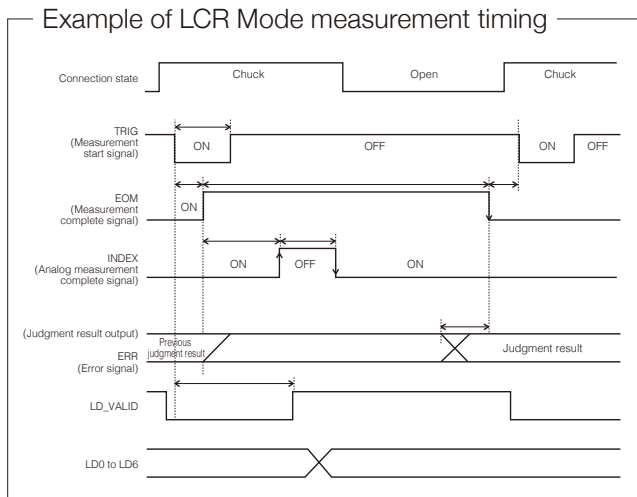

*In this example, the TRIG signal's active edge is the falling edge (ON).

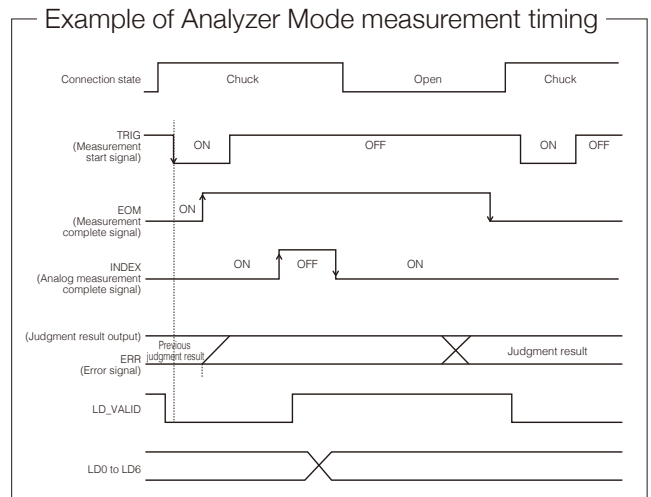

EOM: Off from trigger input to end of measurement processing
INDEX: Off during probe chuck (probe cannot be removed from target)

Instrument

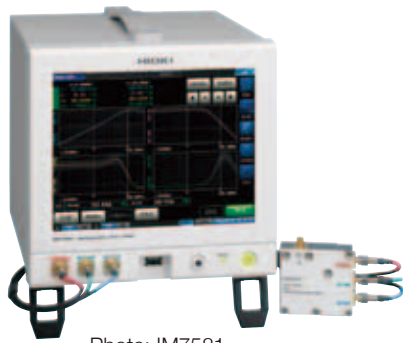

Photo: IM7581



Photo: IM7585

IMPEDANCE ANALYZER

Model (Measurement frequency)	Connection cable length	Order code
IM7580A (1 MHz to 300 MHz)	1 m (3.28 ft)	IM7580A - 1
	2 m (6.56 ft)	IM7580A - 2
IM7581 (100 kHz to 300 MHz)	1 m (3.28 ft)	IM7581 - 01
	2 m (6.56 ft)	IM7581 - 02
IM7583 (1 MHz to 600 MHz)	1 m (3.28 ft)	IM7583 - 01
	2 m (6.56 ft)	IM7583 - 02
IM7585 (1 MHz to 1.3 GHz)	1 m (3.28 ft)	IM7585 - 01
	2 m (6.56 ft)	IM7585 - 02

Composition : Main unit, Test Head, Connection cable

Accessories : Power cord, Instruction manual,
Impedance analyzer application disc

Test fixtures or probes are not included with the main unit.
A dedicated test fixture is required. For more information, please contact your HIOKI distributor.



Accuracy calculation with included software

Free software for automatically calculating measurement accuracy based on user-entered measurement conditions and measurement results can be downloaded from HioKI's website.

Options

Interfaces

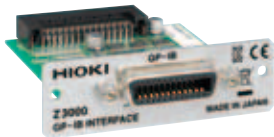

GP-IB INTERFACE Z3000



GP-IB CONNECTION CABLE 9151-02
Cable length : 2 m (6.56 ft)



RS-232C INTERFACE Z3001



RS-232C CABLE 9637
Cable length : 1.8 m (5.91 ft)

*Any interlink-compatible cross-cable can be used as the RS-232C CABLE.

Available soon

- TEST FIXTURE STAND IM9200
- CALIBRATION KIT IM9905
- SMD TEST FIXTURE IM9201
- ADAPTER IM9906 3.5 mm (0.14 in) to 7 mm (0.28 in)

HIOKI

HIOKI E. E. CORPORATION

HEADQUARTERS

81 Koizumi, Ueda, Nagano, 386-1192, Japan
TEL +81-268-28-0562 FAX +81-268-28-0568
http://www.hioki.com / E-mail: os-com@hioki.co.jp

DISTRIBUTED BY

NUBICOM

(주)누비콤

www.nubicom.co.kr

본사

서울특별시 영등포구 경인로 775(문래동 3가, 에이스하이테크시티 3동 201호)
TEL: 070-7872-0701 FAX: 02-2167-3801 E-mail: sales@nubicom.co.kr

대전사무소

대전광역시 유성구 대덕대로 593(도룡동 386-2) 대덕테크비즈니스센터 203호
TEL: 070-7872-0712 FAX: 042-863-2023 E-mail: inyeom@nubicom.co.kr